

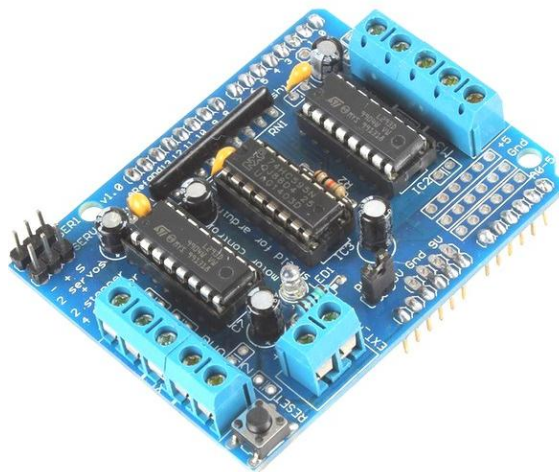

L293D Quadruple H-Bridge Motor Shield For Arduino

The L293D motor shield are quadruple high-current half-H drivers. The L293D shield is designed to provide bidirectional drive currents of up to 600-mA at voltages from 4.5 V to 36 V. This module is designed to drive inductive loads such as relays, solenoids, DC and bipolar stepping motors, as well as other high-current/high-voltage loads in positive-supply applications. Each output is a complete totem-pole drive circuit, with a Darlington transistor sink and a pseudo- Darlington source. Drivers are enabled in pairs, with drivers 1 and 2 enabled by 1,2EN and drivers 3 and 4 enabled by 3,4EN.



SKU: [DRV-1005](#)

Brief Data:

- Supply Voltage Range: 4.5 ~ 36 VDC
- Separate Input-Logic Supply.
- Internal ESD Protection.
- High-Noise-Immunity Inputs.
- Output Current: 600mA.
- Peak Output Current: 1.2A.
- Output Clamp Diodes for Inductive Transient Suppression.

Guide Contents

Guide Contents	2
Overview	4
FAQ	6
Make It!	10
Lets go!	10
Preparation	11
Tutorials	11
Tools	11
Parts List	16
Solder It	19
Use It!	36
Library Install	37
First Install the Arduino Library	37
Power Usage	38
Powering your DC motors, voltage and current requirements	38
How to set up the Arduino + Shield for powering motors	38
Using RC Servos	41
Using Stepper Motors	43
Using DC Motors	46
DC motors are used for all sort of robotic projects.	46
AF_DCMotor Class	48
AF_DCMotor motorname(portnum, freq)	48
setSpeed(speed)	50
run(cmd)	50
AF_Stepper Class	52
AF_Stepper steppername(steps, portnumber)	52
step(steps, direction, style)	53
setSpeed(RPMspeed)	54
onestep(direction, stepstyle)	54
release()	55
Resources	56
Motor ideas and tutorials	56

Downloads	57
Schematics & Layout	57
Firmware	57
Forums	58

Overview

This tutorial is for the now ancient V1 Motor shield. Chances are you have a V2, check out the tutorial <https://learn.adafruit.com/adafruit-motor-shield-v2-for-arduino> This tutorial is for historical reference and previous customers only!

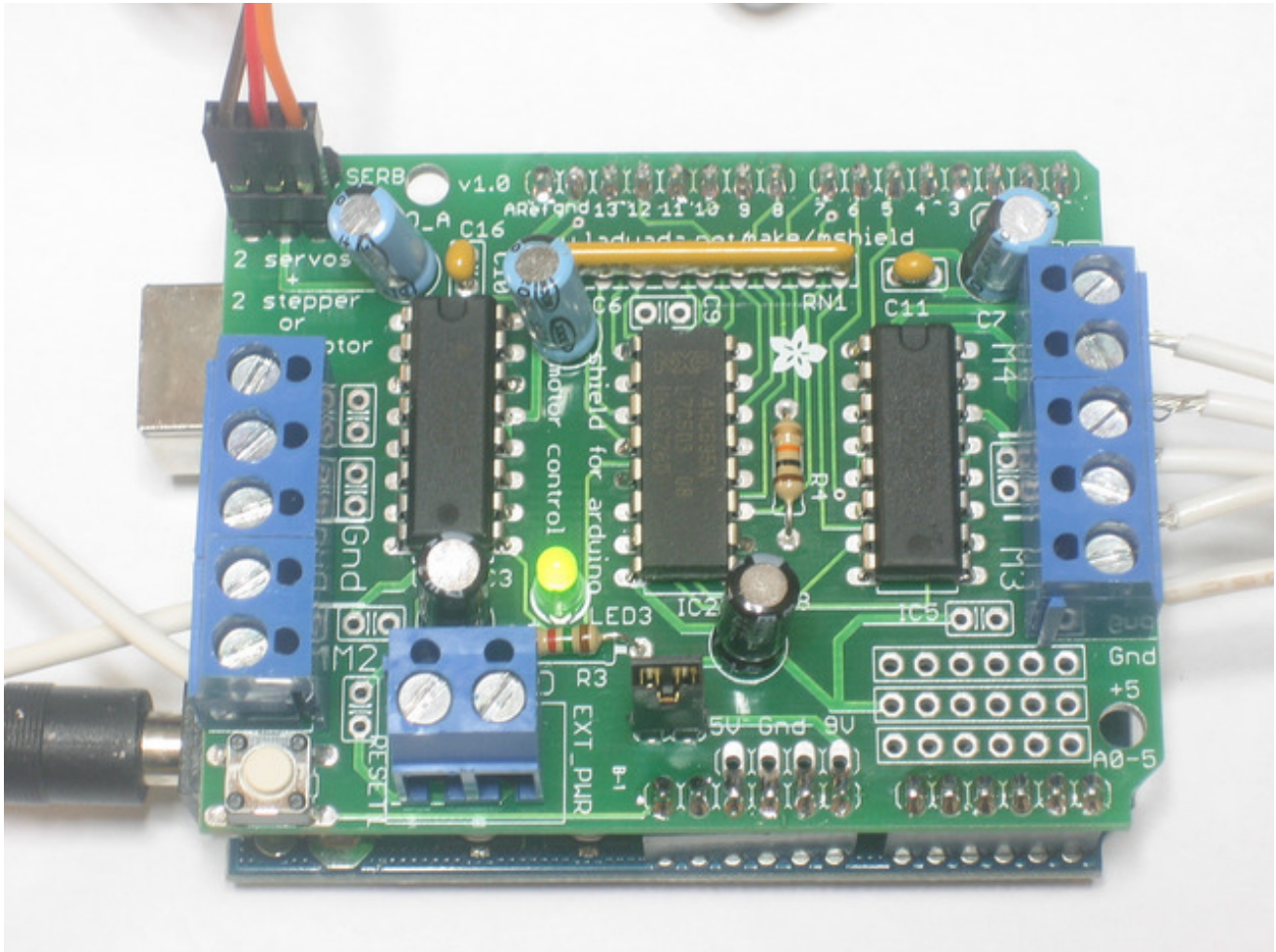

Arduino is a great starting point for electronics, and with a motor shield it can also be a nice tidy platform for robotics and mechatronics. Here is a design for a full-featured motor shield that will be able to power many simple to medium-complexity projects.

- **2 connections for 5V 'hobby' servos** connected to the Arduino's high-resolution dedicated timer - no jitter!
- **Up to 4 bi-directional DC** motors with individual 8-bit speed selection (so, about 0.5% resolution)
- **Up to 2 stepper motors** (unipolar or bipolar) with single coil, double coil, interleaved or micro-stepping.
- 4 H-Bridges: L293D chipset provides 0.6A per bridge (1.2A peak) with thermal shutdown

protection, 4.5V to 25V

- Pull down resistors keep motors disabled during power-up
- Big terminal block connectors to easily hook up wires (10-22AWG) and power
- Arduino reset button brought up top
- 2-pin terminal block to connect external power, for separate logic/motor supplies
- Tested compatible with Mega, Diecimila, & Duemilanove
- [Full kit available for purchase from the Adafruit shop. \(http://adafru.it/81\)](http://adafru.it/81)
- [Download the easy-to-use Arduino software libraries and you're ready to go! \(http://adafru.it/aON\)](http://adafru.it/aON)

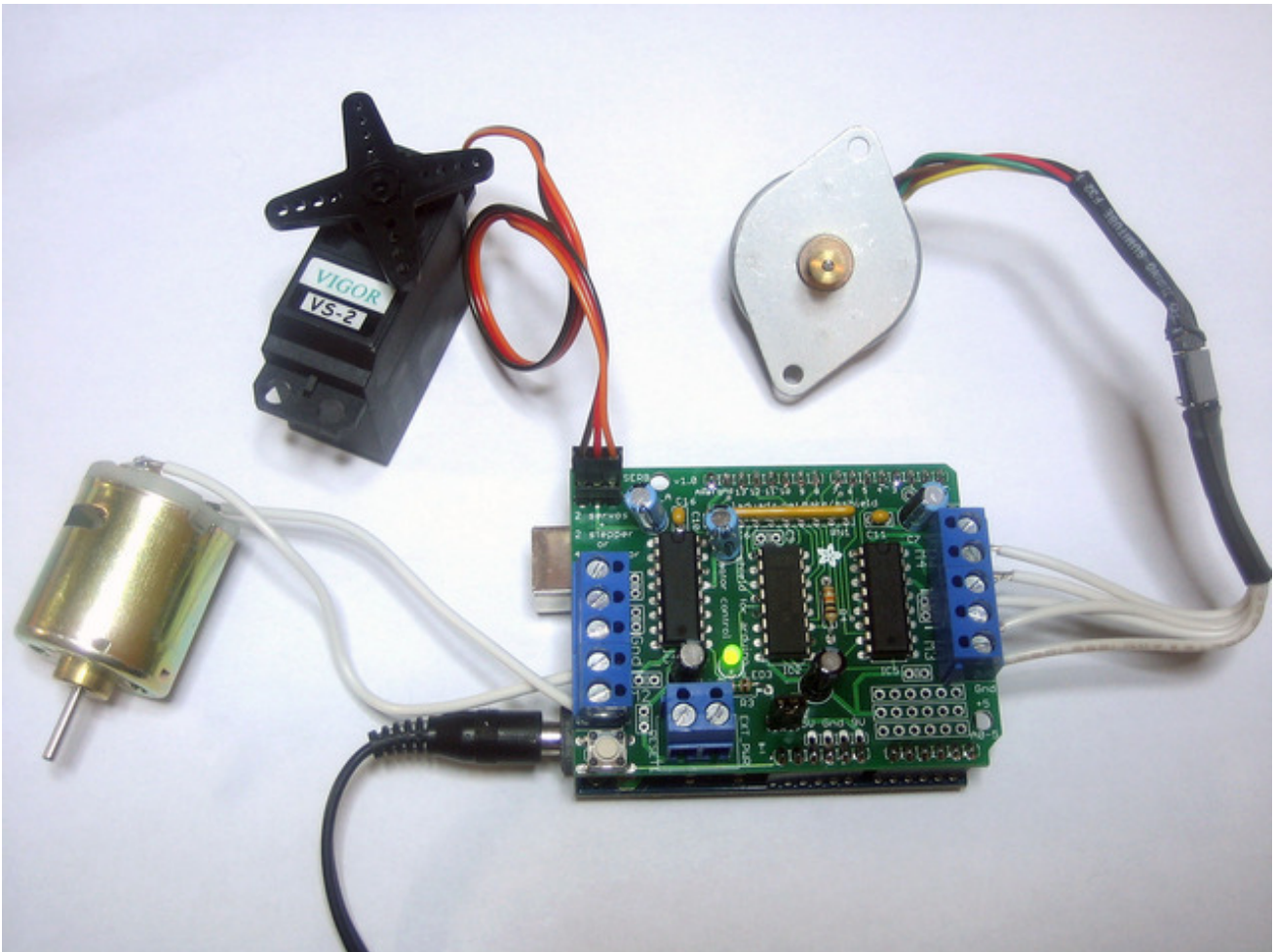

FAQ

This tutorial is for the now ancient V1 Motor shield. Chances are you have a V2, check out the tutorial <https://learn.adafruit.com/adafruit-motor-shield-v2-for-arduino> This tutorial is for historical reference and previous customers only!

How many motors can I use with this shield?

You can use 2 DC servos that run on 5V and up to 4 DC motors or 2 stepper motors (or 1 stepper and up to 2 DC motors)

Can I connect more motors?

No, at this time it is not possible to stack the shield or otherwise connect it up easily to control 4 steppers, for example.

HELP! My motor doesnt work! - HELP! My motor doesnt work!...But the servos work FINE!

Is the LED lit? The Stepper and DC motor connections wont do a single thing if the LED is not lit

Don't bother writing up uploading code or wiring up motors if the LED doesn't light up, its not going to work.

What is the LED for?

The LED indicates the DC/Stepper motor power supply is working. If it is not lit, then the DC/Stepper motors will not run. The servo ports are 5V powered and does not use the DC motor supply.

I'm trying to build this robot and it doesn't seem to run on a 9V battery....

Please read the [user manual \(http://adafru.it/aOz\)](http://adafru.it/aOz) for information about appropriate power supplies.

Can this shield control small 3V motors?

Not really, its meant for larger, 6V+ motors. It does not work for 3V motors unless you overdrive them at 6V and then they will burn out faster

What is the power connector on the shield for? How do I power my motors?

Please read the [user manual \(http://adafru.it/aOz\)](http://adafru.it/aOz) for information about appropriate power supplies.

My Arduino freaks out when the motors are running! Is the shield broken?

Motors take a lot of power, and can cause 'brownouts' that reset the Arduino. For that reason the shield is designed for seperate (split) supplies - one for the electronics and one for the motor.

Doing this will prevent brownouts. Please read the [user manual \(http://adafru.it/aOz\)](http://adafru.it/aOz) for information about appropriate power supplies.

I have good solid power supplies, but the DC motors seem to 'cut out' or 'skip'.

Try soldering a ceramic or disc 0.1uF capacitor between the motor tabs (on the motor itself!) this will reduce noise that could be feeding back into the circuit ([thanks macegr \(http://adafru.it/clc\)!](#))

What if I need more than 600mA per motor?

[You can substitute SN754410's \(at your risk\) or piggyback solder some more L293D drivers on top of the existing ones. \(http://adafru.it/aOz\)](#)

What pins are not used on the motor shield?

All 6 analog input pins are available. They can also be used as digital pins (pins #14 thru 19)

Digital pin 2, and 13 are not used.

The following pins are in use only if the DC/Stepper noted is in use:

Digital pin 11: DC Motor #1 / Stepper #1 (activation/speed control)

Digital pin 3: DC Motor #2 / Stepper #1 (activation/speed control)

Digital pin 5: DC Motor #3 / Stepper #2 (activation/speed control)

Digital pin 6: DC Motor #4 / Stepper #2 (activation/speed control)

The following pins are in use if any DC/steppers are used

Digital pin 4, 7, 8 and 12 are used to drive the DC/Stepper motors via the 74HC595 serial-to-parallel latch

The following pins are used only if that particular servo is in use:

Digital pin 9: Servo #1 control

Digital pin 10: Servo #2 control

Which pins are connected to the DC/Stepper motors?

The DC/Stepper motors are NOT connected to the Arduino directly. They are connected to the 74HC595 latch which is spoken to by the Arduino. You CANNOT talk directly to the motors, you MUST use the motor shield library.

Huh? I don't understand...

[You can try reading this nice overview written by Michael K \(http://adafru.it/aO9\)](#)

How can I connect to the unused pins?

The analog pins (analog 0-5 also known as digital pins 14-19) are broken out in the bottom right corner.

Pin 2 has a small breakout since its the only truly unused pin

The remaining pins are not broken out because they could be used by the motor shield. If you are sure that you are not using those pins then you can connect to them by using stacking

headers when assembling the kit or soldering onto the top of the header with wires, or using a "Wing shield"

I get the following error trying to run the example code: "error: AFMotor.h: No such file or directory...."

Make sure you have installed the AFMotor library

How do I install the library?

[Read our tutorial on libraries \(http://adafru.it/aYG\)](http://adafru.it/aYG)

I have two stepper motors and I want to run them simultaneously but the example code can only control one and then the other?

The stepper motor library `step()` routine does not have the ability to run both motors at a time. Instead, you will have to 'interleave' the calls. For example, to have both motors step forward 100 times you must write code like this:

```
for (i=0; i<100; i++) {  
  motor1.step(1, FORWARD, SINGLE);  
  motor2.step(1, FORWARD, SINGLE);  
}
```

If you want more intelligent control, check out the AccelStepper library (in the Downloads section) which has some concurrent stepper motor control examples

What are some 'suggested motors'?

Most people buy motors from surplus shops and no motor will make everyone happy

However, since its a popular question, I suggest buying motors from Pololu ([DC Servos \(http://adafru.it/aOa\)](http://adafru.it/aOa), [DC motors \(http://adafru.it/aOb\)](http://adafru.it/aOb)) or Jameco ([all sorts \(http://adafru.it/aOc\)](http://adafru.it/aOc)!) As well as the many [surplus webshops \(http://adafru.it/aOd\)](http://adafru.it/aOd).

Is the motor shield compatible with the UNO R3 or Mega R3? What about the extra pins?

The motor shield is compatible with the R3 UNO and MEGA. The R3s have 2 extra pins on each header. These are duplicates of other pins on the header and are not needed by the shield.

I'm using a 4WD robot platform and I can't get anything to work.

The motors used in the 4WD robot platforms from Maker Shed, DF Robotics, Jameco and others have a lot of "brush noise". This feeds back into the Arduino circuitry and causes unstable operation. This problem can be solved by soldering 3 noise suppression capacitors to the motor. 1 between the motor terminals, and one from each terminal to the motor casing.

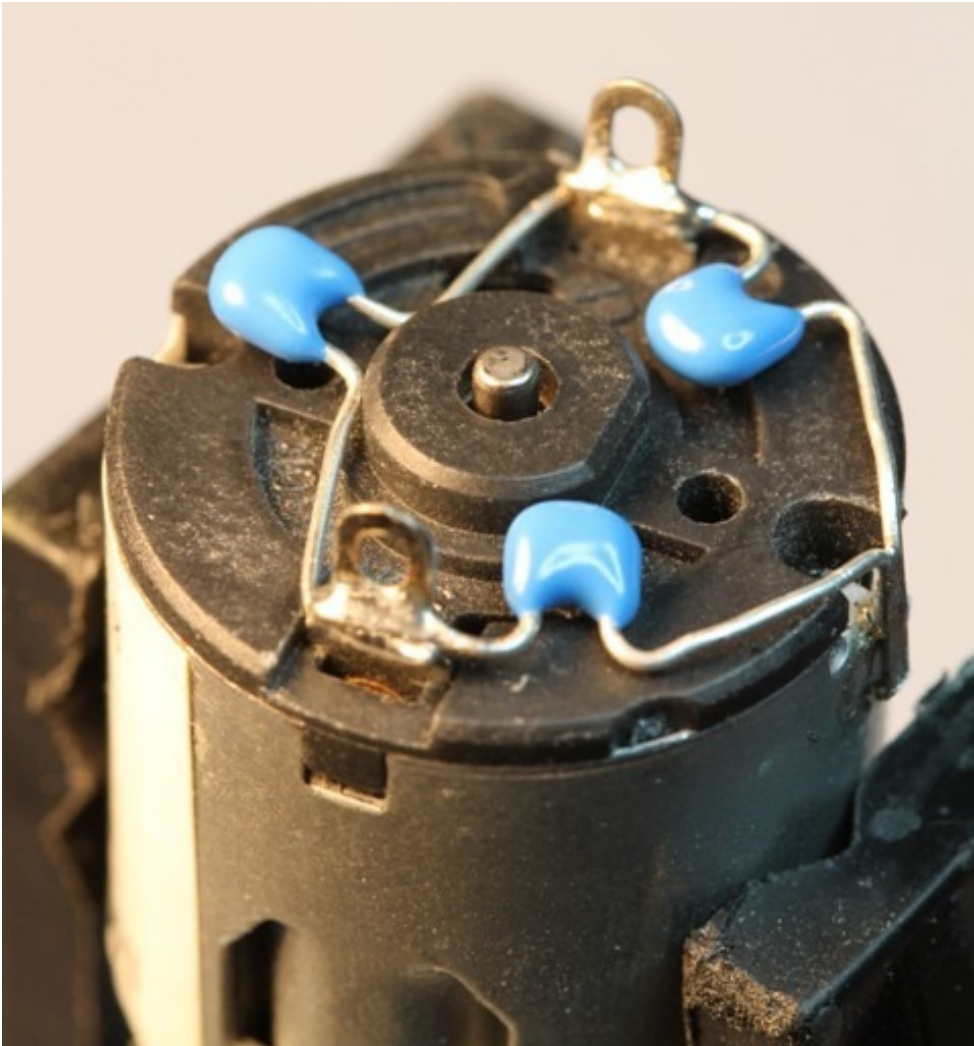

But my motor already has a capacitor on it and it still doesn't work.

These motors generate a lot of brush noise and usually need the full 3-capacitor treatment for adequate suppression.

Why don't you just design capacitors into the shield?

They would not be effective there. The noise must be suppressed at the source or the motor leads will act like antennae and broadcast it to the rest of the system.

Make It!

This tutorial is for the now ancient V1 Motor shield. Chances are you have a V2, check out the tutorial <https://learn.adafruit.com/adafruit-motor-shield-v2-for-arduino> This tutorial is for historical reference and previous customers only!

Lets go!

This is a vey easy kit to make, just go through each of these steps to build the kit

1. [Tools and preparation \(http://adafru.it/aOv\)](http://adafru.it/aOv)
2. [Check the parts list \(http://adafru.it/aOw\)](http://adafru.it/aOw)
3. [Solder it \(http://adafru.it/aOx\)](http://adafru.it/aOx)

Preparation

This tutorial is for the now ancient V1 Motor shield. Chances are you have a V2, check out the tutorial <https://learn.adafruit.com/adafruit-motor-shield-v2-for-arduino> This tutorial is for historical reference and previous customers only!

Tutorials

- [Learn how to solder with tons of tutorials! \(http://adafru.it/aOm\)](http://adafru.it/aOm)
(<http://adafru.it/aOm>)
- [Don't forget to learn how to use your multimeter too! \(http://adafru.it/aOy\)](http://adafru.it/aOy)

Tools

There are a few tools that are required for assembly. None of these tools are included. If you don't have them, now would be a good time to borrow or purchase them. They are very very handy whenever assembling/fixing/modifying electronic devices! I provide links to buy them, but of course, you should get them where ever is most convenient/inexpensive. Many of these parts are available in a place like Radio Shack or other (higher quality) DIY electronics stores.

Soldering iron

Any entry level 'all-in-one' soldering iron that you might find at your local hardware store should work. As with most things in life, you get what you pay for.

Upgrading to a higher end soldering iron setup, like the [Hakko FX-888 that we stock in our store \(http://adafru.it/180\)](http://adafru.it/180), will make soldering fun and easy.

Do not use a "ColdHeat" soldering iron! They are not suitable for delicate electronics work and can damage the kit ([see here \(http://adafru.it/aOo\)](http://adafru.it/aOo)).

[Click here to buy our entry level adjustable 30W 110V soldering iron. \(http://adafru.it/180\)](http://adafru.it/180)

[Click here to upgrade to a Genuine Hakko FX-888 adjustable temperature soldering iron. \(http://adafru.it/303\)](http://adafru.it/303)



Solder

You will want rosin core, 60/40 solder. Good solder is a good thing. Bad solder leads to bridging and cold solder joints which can be tough to find.

[Click here to buy a spool of leaded solder \(recommended for beginners\).](http://adafru.it/145) (<http://adafru.it/145>)

[Click here to buy a spool of lead-free solder.](http://adafru.it/734) (<http://adafru.it/734>)



Multimeter

You will need a good quality basic multimeter that can measure voltage and continuity.

[Click here to buy a basic multimeter.](http://adafru.it/71) (<http://adafru.it/71>)

[Click here to buy a top of the line multimeter.](http://adafru.it/308) (<http://adafru.it/308>)

[Click here to buy a pocket multimeter.](http://adafru.it/850) (<http://adafru.it/850>)



Flush Diagonal Cutters



You will need flush diagonal cutters to trim the wires and leads off of components once you have soldered them in place.

[Click here to buy our favorite cutters. \(http://adafru.it/152\)](http://adafru.it/152)



Solder Sucker

Strangely enough, that's the technical term for this desoldering vacuum tool. Useful in cleaning up mistakes, every electrical engineer has one of these on their desk.

[Click here to buy a one. \(http://adafru.it/148\)](http://adafru.it/148)

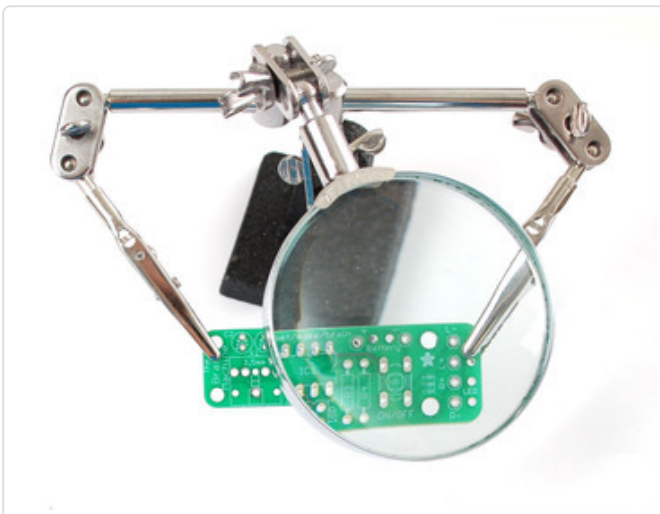

Helping Third Hand With Magnifier

Not *absolutely* necessary but will make things go much much faster, and it will make soldering much easier.

[Pick one up here. \(http://adafru.it/291\)](http://adafru.it/291)

Parts List

This tutorial is for the now ancient V1 Motor shield. Chances are you have a V2, check out the tutorial <https://learn.adafruit.com/adafruit-motor-shield-v2-for-arduino> This tutorial is for historical reference and previous customers only!

Image	Name	Description	Distributor	Qty
	PCB	Printed Circuit Board	Adafruit	1
	IC1, IC2	L293D Dual H-bridge *See note on usage page for replacing with SN754410	L293D	2
	IC3	74HC595N Serial to parallel output latch	74HC595N	1
	IC1' and IC2'	16 pin sockets (OPTIONAL!) These are included in kits as of July 2010	Generic	2
	LED1	3mm LED, any color Motor power indicator	3mm LED	1
	R1	1.5K resistor for LED1	1/4W 5% resistor	1

				
	R2	10K pull-down resistor Brown, Black, Orange, Gold	1/4W 5% resistor	1
	RN1	10-pin bussed 10K-100K resistor network	100K resistor network	1
	C2, C4, C6	0.1uF ceramic capacitor	Generic	3
	C1, C3, C5	100uF / 6V capacitor (or bigger)	100uF/6V cap	3
	C7, C8	47uF / 25V capacitor (or bigger)	47uF/25V cap	2
	X1	5-position 3.5mm terminal block (Or a 3-position and a 2-position)	3.5mm terminals	2
	X2	2-position 3.5mm terminal block	3.5mm terminals	1

				
	RESET	6mm tactile switch	6mm tact switch	1
	PWR	Jumper/shunt	0.1" jumper	1
		36 pin male header (1x36)	Generic	1

Solder It

This tutorial is for the now ancient V1 Motor shield. Chances are you have a V2, check out the tutorial <https://learn.adafruit.com/adafruit-motor-shield-v2-for-arduino> This tutorial is for historical reference and previous customers only!

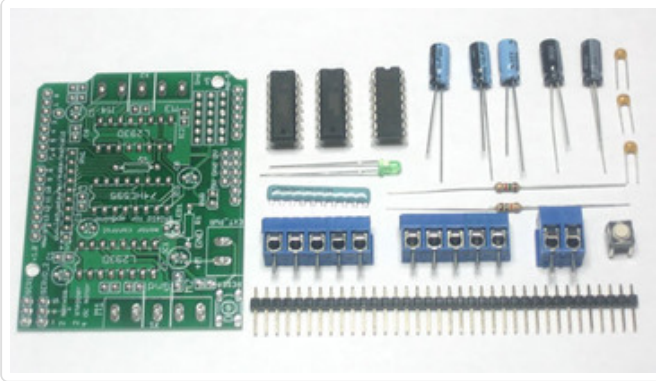

First, check that you have all the parts! Look over the [parts list here \(http://adafru.it/aOw\)](http://adafru.it/aOw) and shown on the left.

Also check to make sure you have the necessary [tools for assembly. \(http://adafru.it/aOv\)](http://adafru.it/aOv)

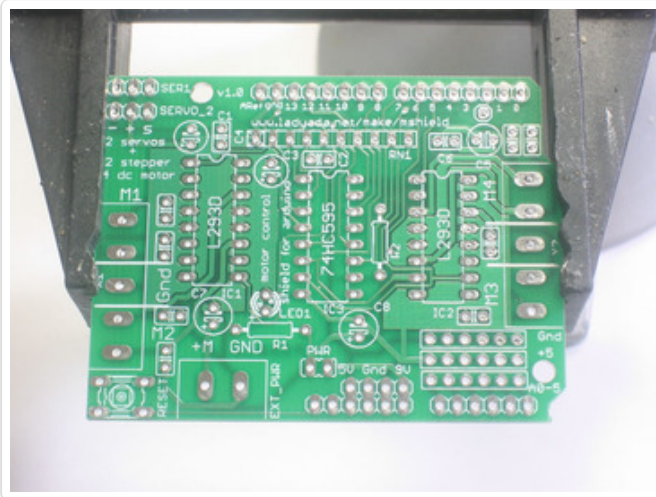

Place the motor shield PCB in a vise or other circuit-board holder and turn on your soldering iron to 700 degrees.

The first parts to go in are the two resistors, **R1 (Brown Green Red Gold)** and **R2 (Brown Black Orange Gold)**. Bend the resistors so that they look like staples, as seen in this photo.

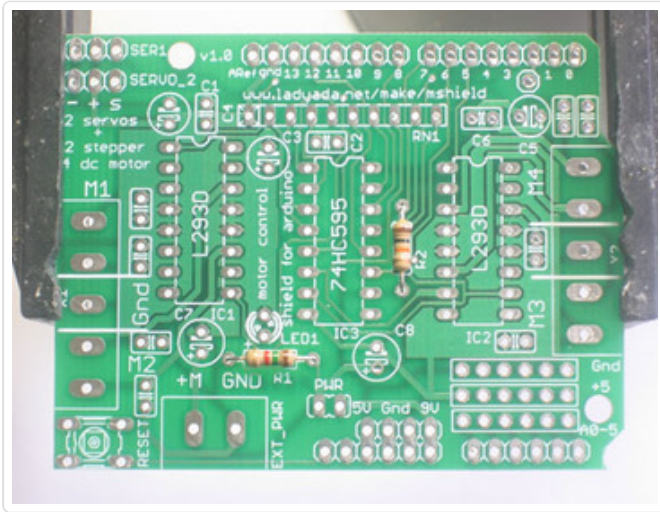

Next, slip the resistors into the PCB as shown, so that they sit flat against the circuit board. Bend the wire legs out a bit so that when the board is flipped over

Resistors are not polarized, that means you can put them in "either way" and they'll work just fine.

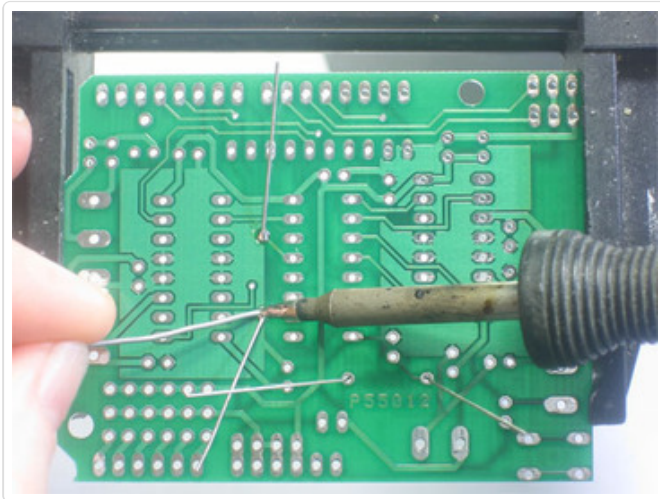

Using your soldering iron tip, heat the resistor wire lead and the metal ring (pad) at the same time, after a few seconds, poke a little solder in so that it melts into a nice cone. Remove the solder and then remove the soldering iron. Do this for all 4 wires.

Check your work, you should have clean solder joints.

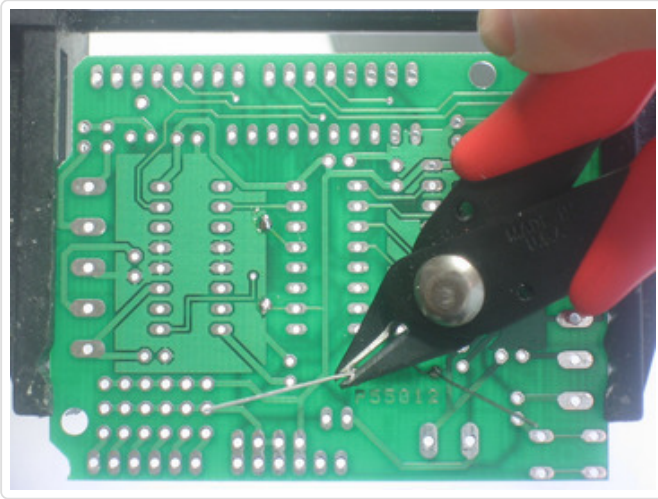
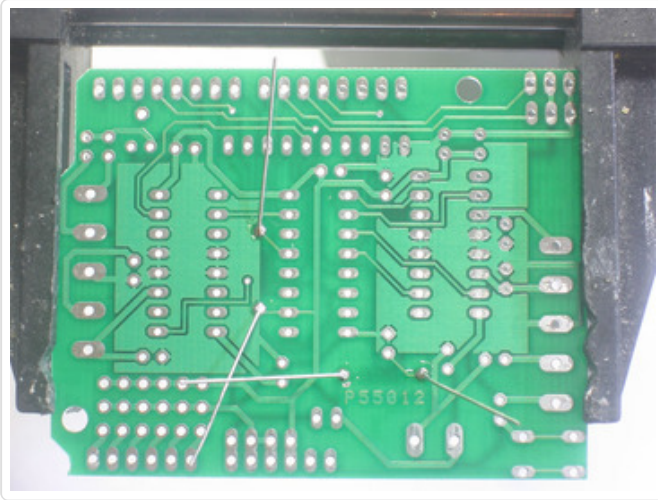

Clip the long leads, just above the solder joint using diagonal cutters.

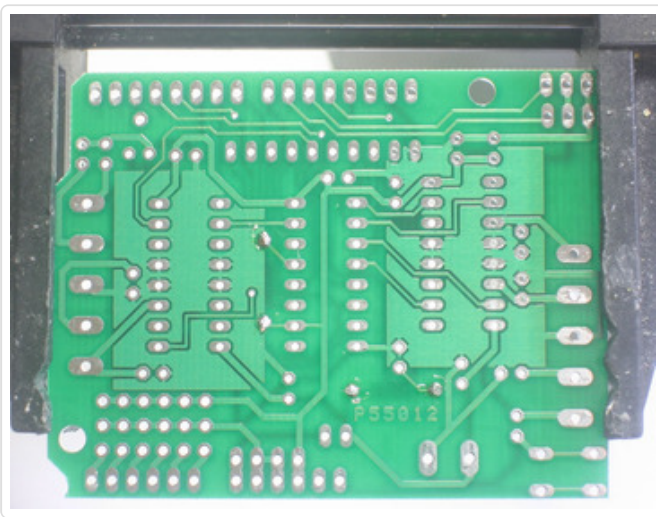

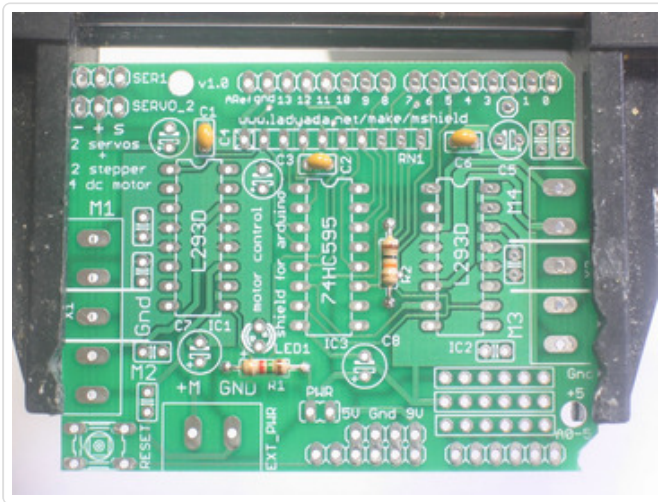

Next place the three yellow ceramic capacitors **C4**, **C2** and **C6**. Ceramic capacitors are not polarized so you can put them in "either way" and they work fine.

Bend the leads out just like you did with the resistors.

Solder all 6 wires, then clip them as you did with the resistors.

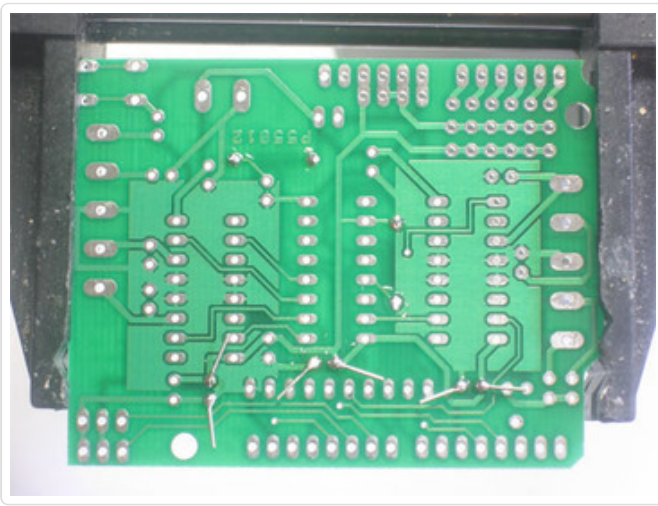
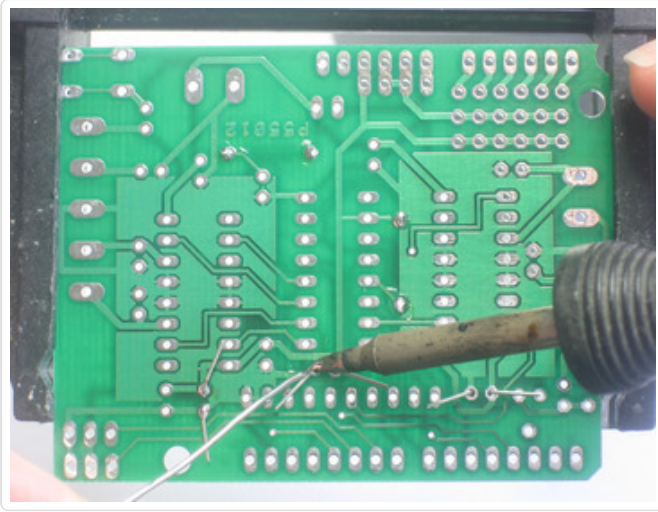

Next is the 6mm tactile switch **RESET** and the resistor network **RN1**. The tact switch is used to

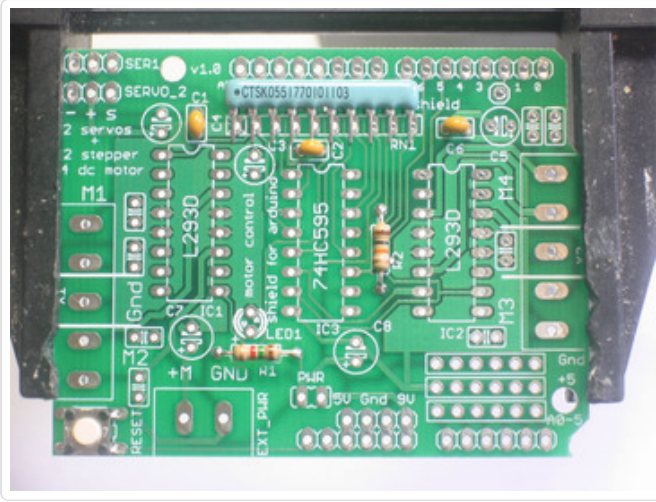

reset the Arduino since its not possible to reach the reset button once the motor shield is on.

The resistor network is used *topull-down* the pins on the motor driver chips so that they don't power up the motors before the Arduino sketch tells them to.

The tactile switch can go in 'either way'. The resistor network, however, must go in a certain way. Make sure the end with a dot is positioned so it is at the same end as the X in the silkscreened image of the resistor network. (See picture on left).

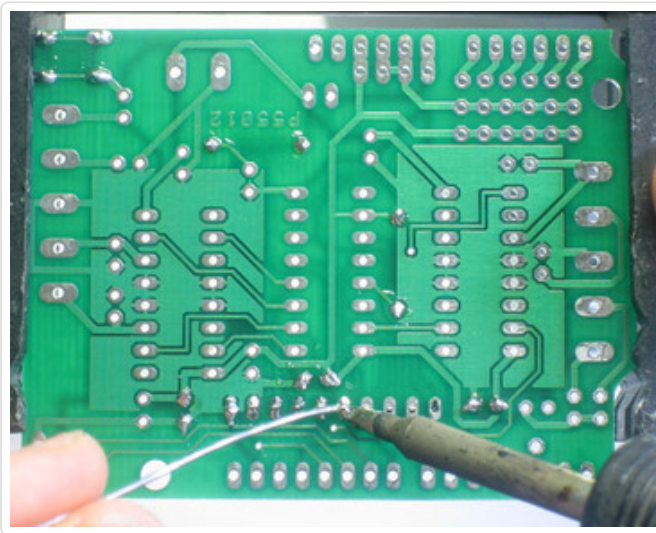

Flip the board over and solder in the resistor network and switch. You won't need to clip the leads as they are quite short already.

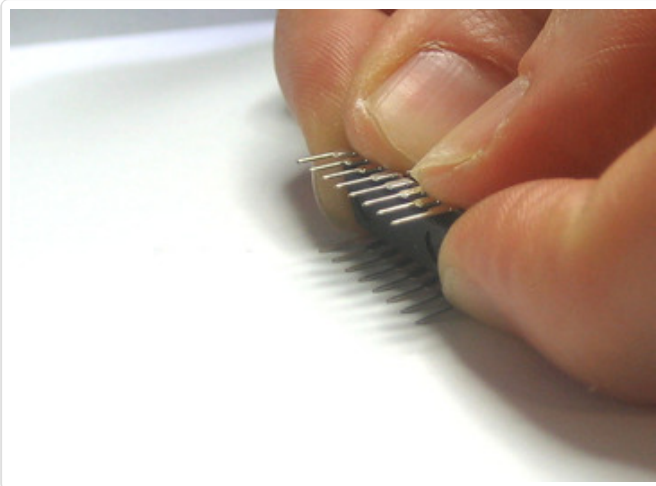

Next are the three integrated circuits (ICs) **IC1**, **IC2** and **IC3**. When ICs come from the factory, the legs are angled out somewhat which makes it difficult to insert them into the PCB. Prepare them for soldering by gently bending the legs against a flat tabletop so that they are perfectly straight.



The latest kits from Adafruit come with 2 16-pin sockets for the L293D motor drivers. They are OPTIONAL and not necessary for operation.

If you are not experienced with driving motors (your likelihood of wiring up a mis-specified motor is high) you should install these so if the L293Ds are destroyed you can easily replace them

If you are experienced with driving motors, you may want to skip the sockets as they decrease the chips' heat-sinking abilities.

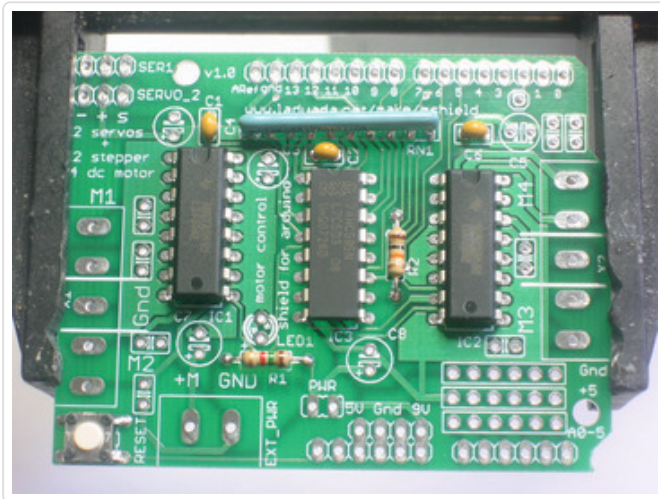

ICs must be placed in the correct orientation to work properly. To help with placement, each chip has a U notch at the top of the chip. On the circuit board there is a printed out image of the chip outline and one end has a U notch. Make sure the chip notch is on the same end as the image notch. In this PCB, all are facing the same way.

Gently insert the three chips. Check to make sure none of the legs got bent or broken.

The 74HC595 goes in the middle, and the two L293Ds go on either side.

Solder each pin of the chips.

The four 'middle' pins of the L293D motor driver chips are tied to a large heat sink and thus may end up getting 'bridged' with solder as shown in the second image.

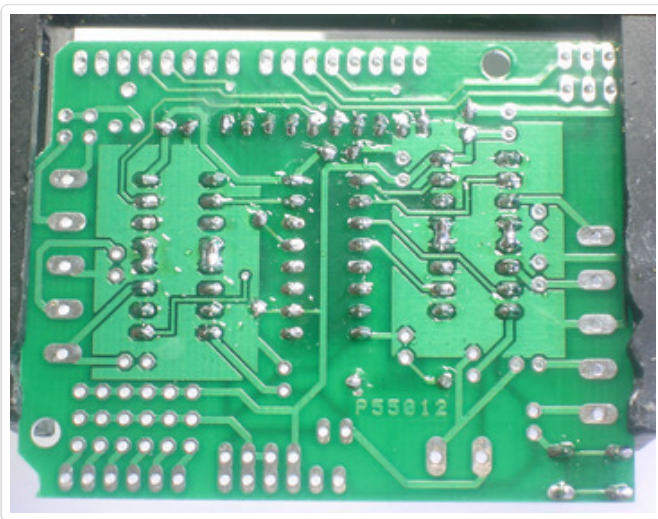
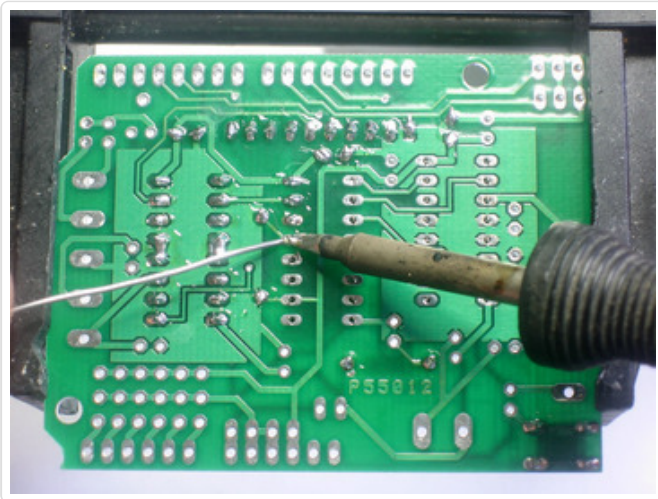
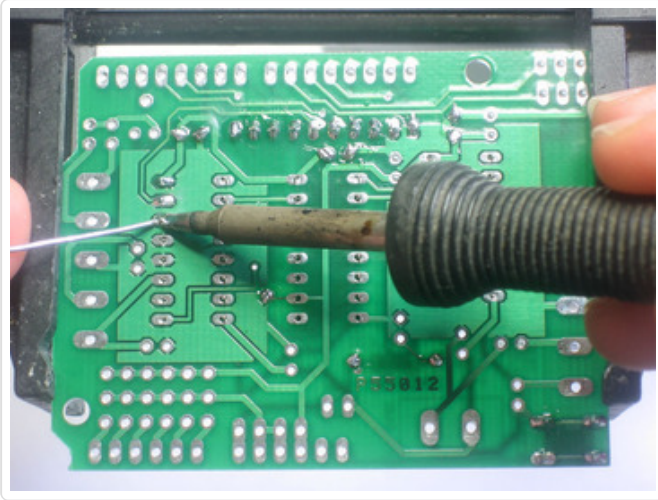

Next are the three 100uF electrolytic

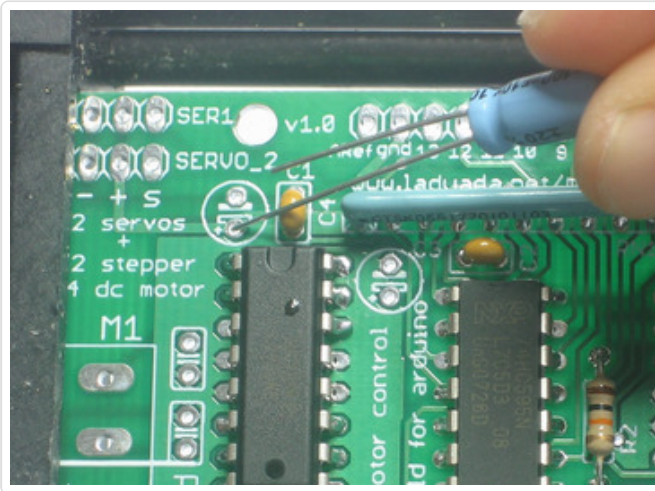

capacitors **C1**, **C3** and **C5**. Electrolytic capacitors are polarized and must be placed in the correct orientation or they could pop! The long leg of the capacitor is the positive (+) leg and goes into the hole marked with a +. The close-up images shown here indicate with hole is the + one.

Capacitors are not color-coded. The body color can vary from blue to violet to green to black so **be sure to read the value on the side, don't depend on the color!**

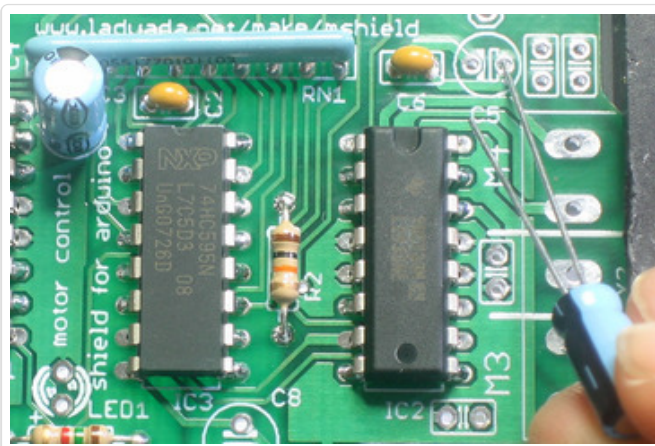
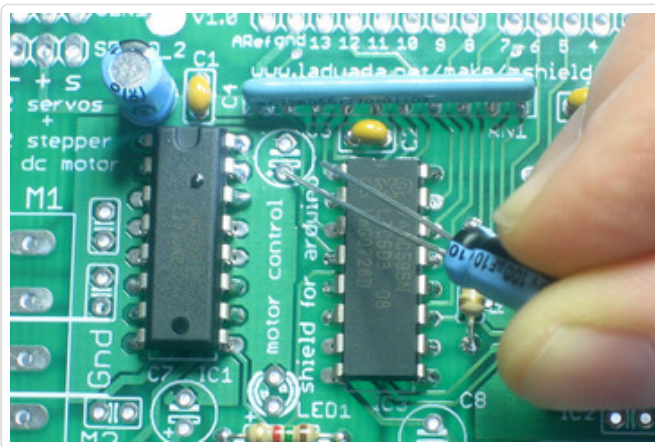

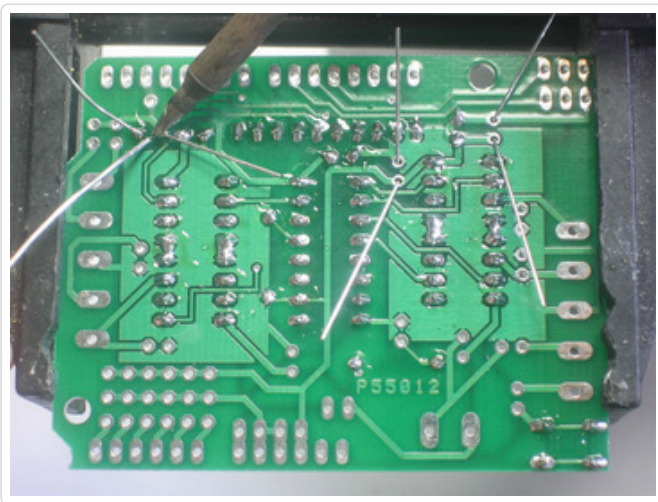

After double-checking their polarity, solder and clip the three capacitors.

Place the two 47uF remaining electrolytic capacitors, **C7** and **C8**

These are also polarized so make sure the long lead is inserted into the + hole in the silkscreened image.

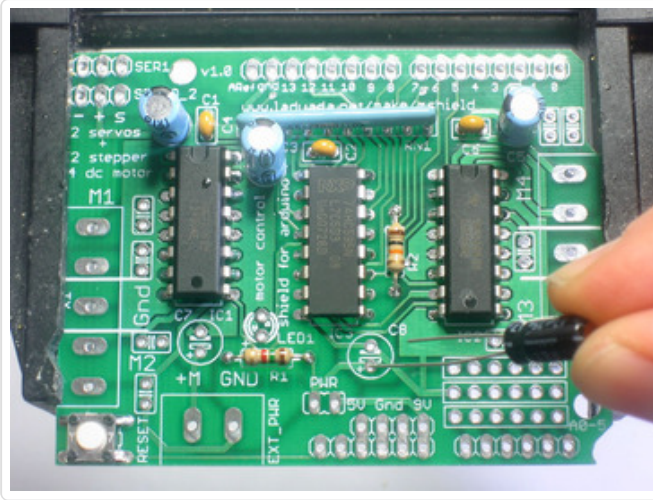

Capacitors are not color-coded. The body color can vary from blue to violet to green to black so **be sure to read the value on the side, don't depend on the color!**

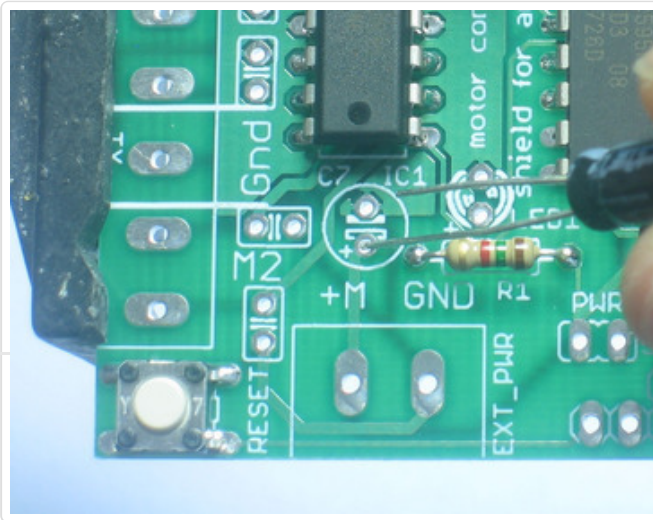

Solder and clip the two capacitors.

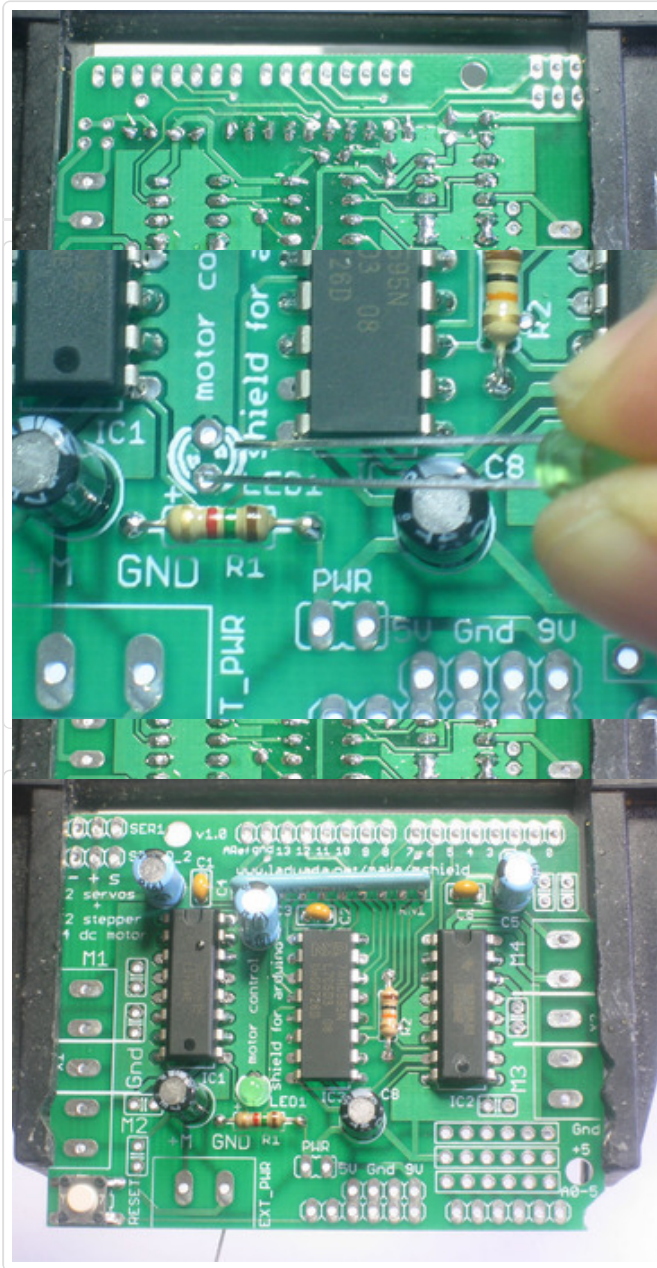

Next is the 3mm LED used to indicate motor power. LEDs are polarized, just like capacitors, and the long lead is the positive (+) lead.

Make sure the LED is placed correctly otherwise it wont work!

Solder and clip the LED leads.

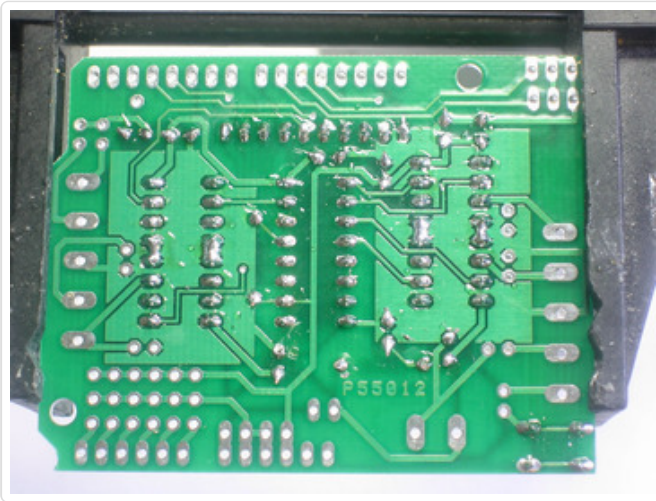
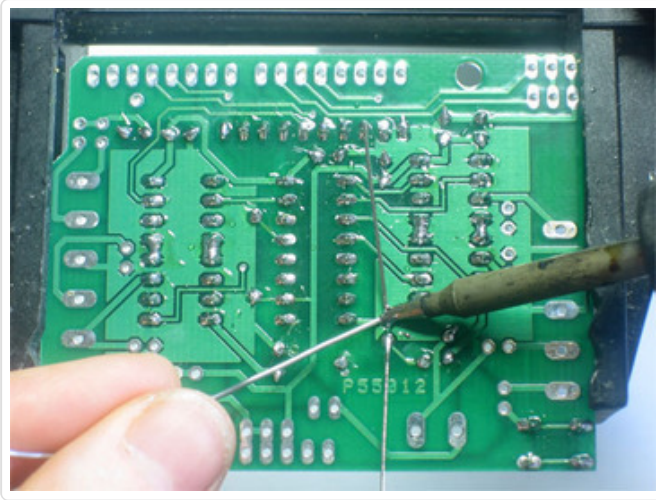

Next its time to make the headers for the jumper, servos and arduino.

We use one stick of 36-pin 'breakaway' header, and break it apart to make smaller strips. You can use diagonal cutters or pliers to snap off the pieces.

Break the 36-pin header into 2 8-pin, 2 6-pin, 2 3-pin and 1 2-pin headers.

If you have an NG arduino, you may want 1 6-pin header and 1 4-pin header instead of 2 6-pin headers.

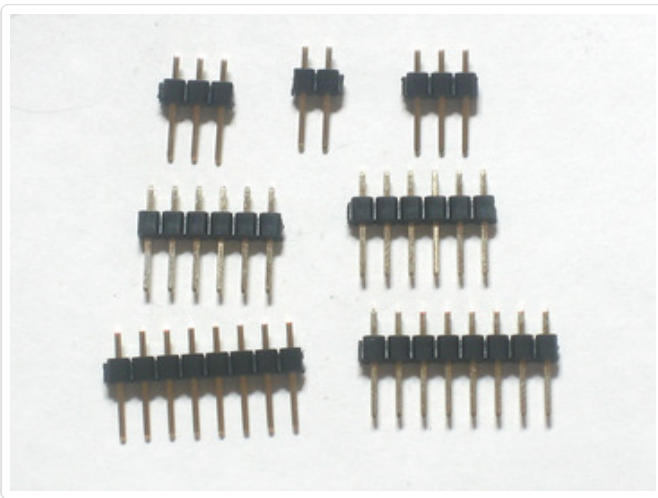
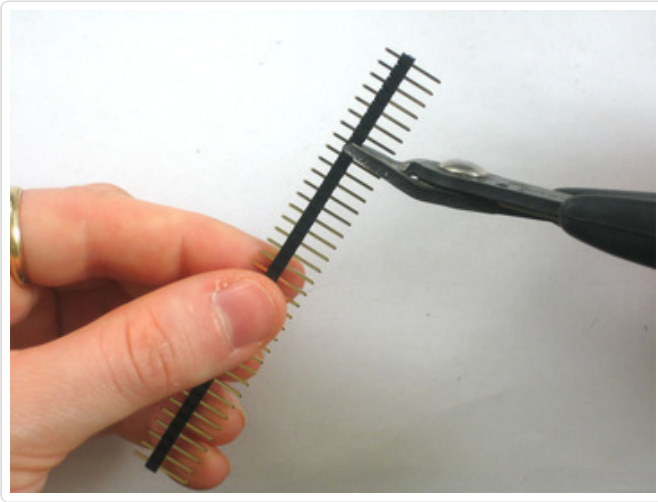

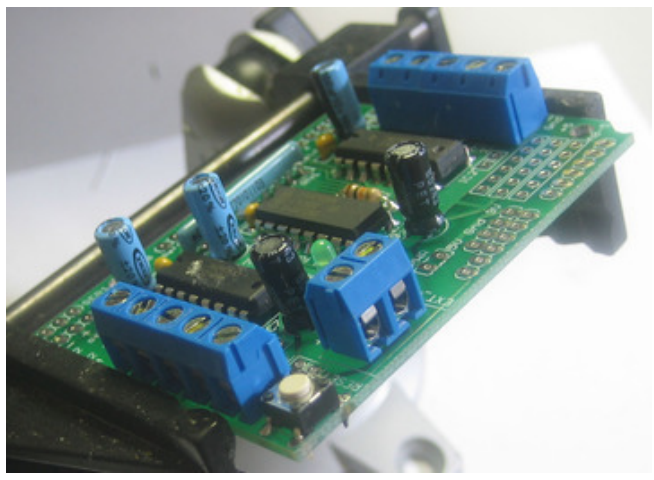

The 2 3-pin pieces go in the servo connections in the top left corner. The 2-pin piece goes in the PWR jumper in the bottom center.

Also, place the 3 large screw terminals for the motor and external motor-power wires. If you received only 2 and 3-position terminal blocks, slide them together so that you have 2 5-position terminals and 1 2-position terminal.

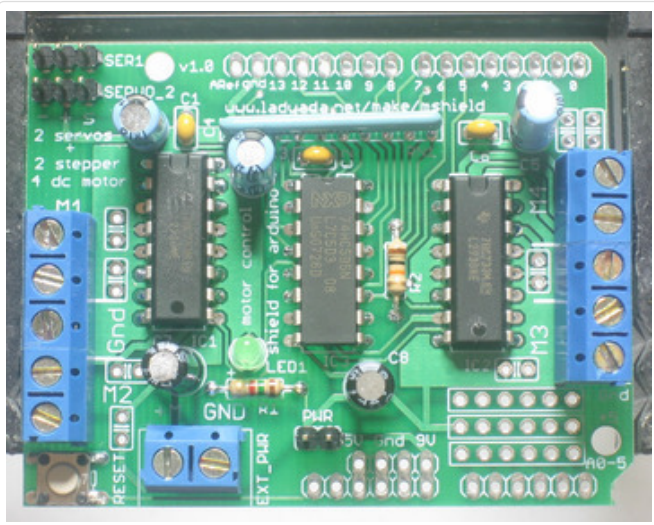

Solder in the 3 pieces of header and the three terminal blocks.

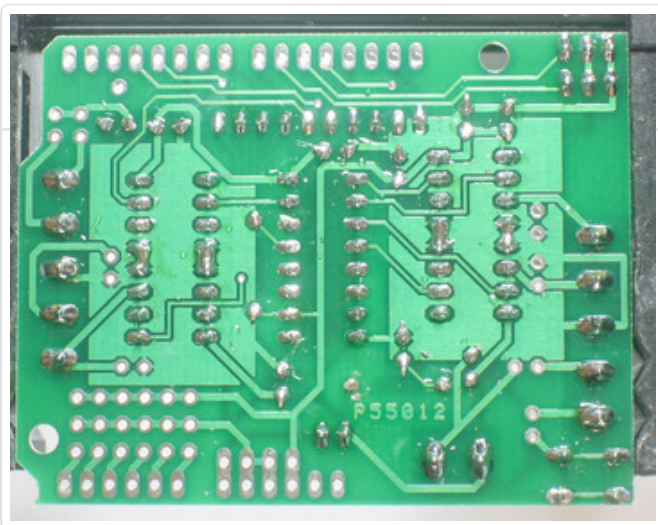
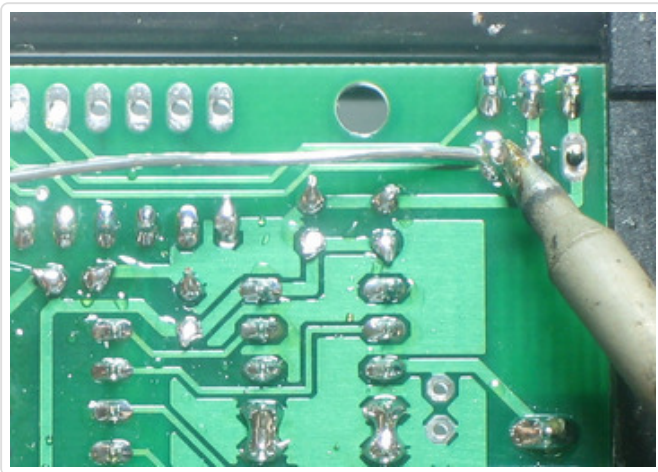
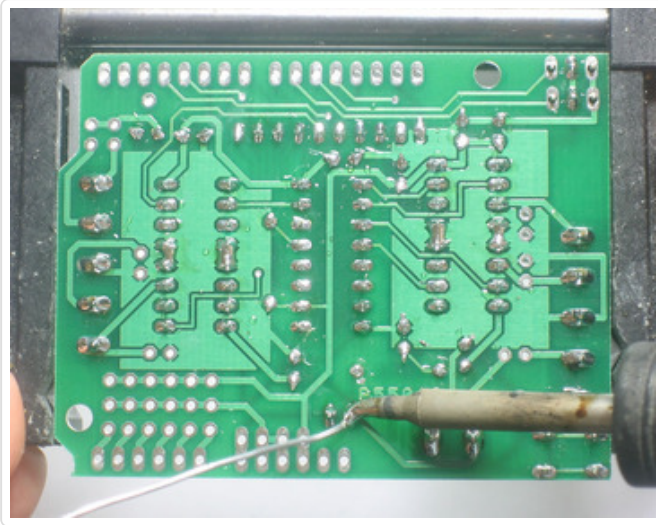

Next, place the 8-pin and 6-pin headers into the Arduino board. This will make sure that the headers are perfectly lined up. Make sure the Arduino is not plugged in or powered!

Place the motor shield on top of the Arduino, making sure that all the header lines up.

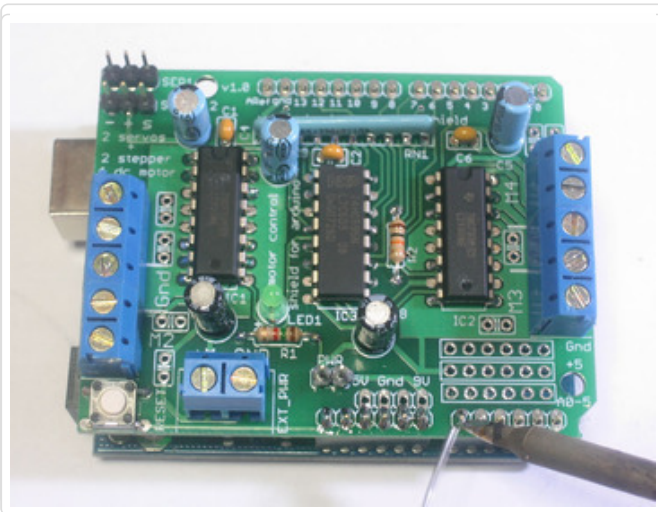
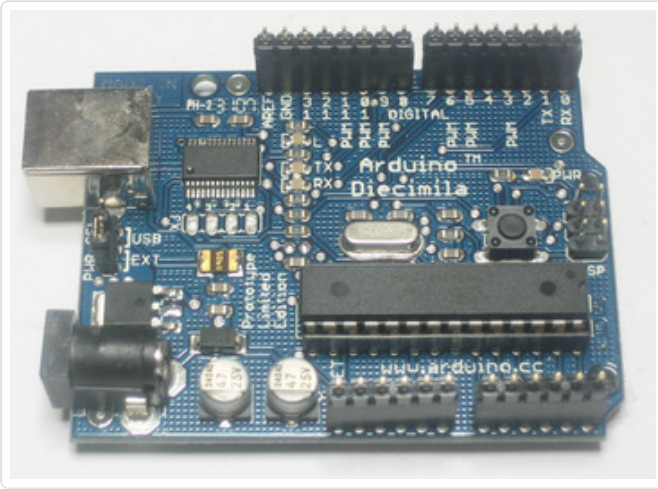

Solder in each pin of the header.

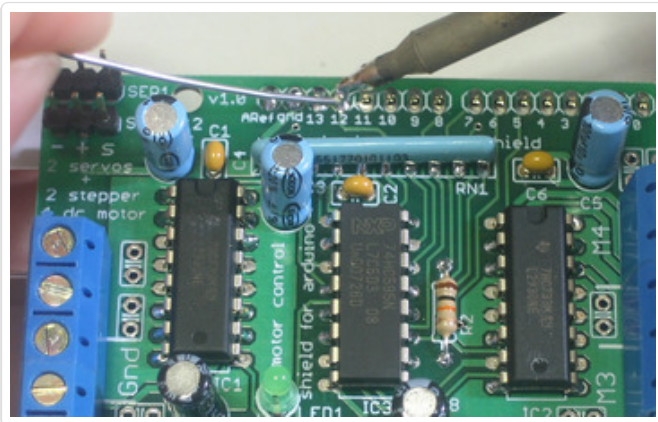

You're done!

Now go read the user manual. (<http://adafru.it/aOz>)

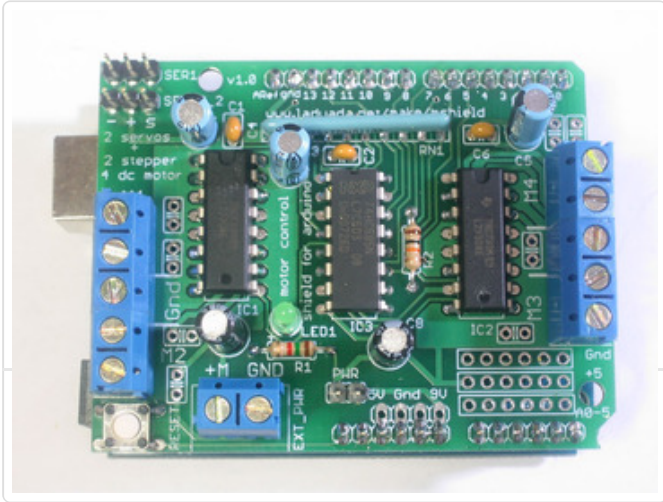

Use It!

This tutorial is for the now ancient V1 Motor shield. Chances are you have a V2, check out the tutorial <https://learn.adafruit.com/adafruit-motor-shield-v2-for-arduino> This tutorial is for historical reference and previous customers only!

The Adafruit Motor Shield kit is a great motor controller for Arduino, but it does a little care to make sure it's used correctly. Please read through all the User manual sections at left, especially the section about library installation and power requirements!

Library Install

This tutorial is for the now ancient V1 Motor shield. Chances are you have a V2, check out the tutorial <https://learn.adafruit.com/adafruit-motor-shield-v2-for-arduino> This tutorial is for historical reference and previous customers only!

First Install the Arduino Library

Before you can use the Motor shield, you **must** install the **AF_Motor** Arduino library - this will instruct the Arduino how to talk to the Adafruit Motor shield, and it isn't optional!

1. [First, grab the library from github \(http://adafru.it/aOA\)](http://adafru.it/aOA)
2. Uncompress the ZIP file onto your desktop
3. Rename the uncompressed folder **AFMotor**
4. Check that inside **AFMotor** is **AFMotor.cpp** and **AFMotor.h** files. If not, check the steps above
5. Place the **AFMotor** folder into your *arduinorsketchfolder/libraries* folder. For Windows, this will probably be something like **MY Documents/Arduino/libraries** for Mac it will be something like **Documents/arduino/libraries**. If this is the first time you are installing a library, you'll need to create the **libraries** folder. Make sure to call it **libraries** exactly, no caps, no other name.
6. Check that inside the **libraries** folder there is the **AFMotor** folder, and inside **AFMotor** is **AFMotor.cpp** **AFMotor.h** and some other files
7. Quit and restart the IDE. You should now have a submenu called **File->Examples->AFMotor->MotorParty**

Power Usage

This tutorial is for the now ancient V1 Motor shield. Chances are you have a V2, check out the tutorial <https://learn.adafruit.com/adafruit-motor-shield-v2-for-arduino> This tutorial is for historical reference and previous customers only!

Powering your DC motors, voltage and current requirements

Motors need a lot of energy, especially cheap motors since they're less efficient. The first important thing to figure out what voltage the motor is going to use. If you're lucky your motor came with some sort of specifications. Some small hobby motors are only intended to run at 1.5V, but its just as common to have 6-12V motors. The motor controllers on this shield are designed to run from **4.5V to 25V**.

MOST 1.5-3V MOTORS WILL NOT WORK

Current requirements: The second thing to figure out is how much current your motor will need. The motor driver chips that come with the kit are designed to provide up to 600 mA per motor, with 1.2A peak current. Note that once you head towards 1A you'll probably want to put a heatsink on the motor driver, otherwise you will get thermal failure, possibly burning out the chip.

On using the SN754410: Some people use the [SN754410 \(http://adafru.it/aOB\)](http://adafru.it/aOB) motor driver chip because it is pin-compatible, has output diodes and can provide 1A per motor, 2A peak. After careful reading of the datasheet and discussion with TI tech support and power engineers it appears that **the output diodes were designed for ESD protection only** and that using them as kickback-protection is a hack and not guaranteed for performance. For that reason the kit does not come with the SN754410 and instead uses the L293D with integrated kickback-protection diodes. If you're willing to risk it, and need the extra current, feel free to buy SN754410's and replace the provided chips.

Need more power? [Buy another set of L293D drivers and solder them right on top of the ones on the board \(piggyback\) \(http://adafru.it/aOC\)](http://adafru.it/aOC). Voila, double the current capability! You can solder 2 more chips on top before it probably isnt going to get you much benefit

You can't run motors off of a 9V battery so don't even waste your time/batteries! Use a big Lead Acid or NiMH battery pack. Its also very much suggested that you set up two power supplies (split supply) one for the Arduino and one for the motors. **99% of 'weird motor problems'** are due to noise on the power line from sharing power supplies and/or not having a powerful enough supply!

How to set up the Arduino + Shield for powering motors

Servos are powered off of the same regulated 5V that the Arduino uses. This is OK for the

small hobby servos suggested. If you want something beefier, cut the trace going to + on the servo connectors and wire up your own 5-6V supply!

The DC motors are powered off of a 'high voltage supply' and NOT the regulated 5V. **Don't connect the motor power supply to the 5V line.** This is a very very very bad idea unless you are sure you know what you're doing!

There are two places you can get your motor 'high voltage supply' from. One is the DC jack on the Arduino board and the other is the 2-terminal block on the shield that is labeled **EXT_PWR**. The DC Jack on the Arduino has a protection diode so you won't be able to mess things up too bad if you plug in the wrong kind of power. However the **EXT_PWR terminals on the shield do not have a protection diode** (for a fairly good reason). **Be utterly careful not to plug it in backwards** or you will destroy the motor shield and/or your Arduino!

Here's how it works:

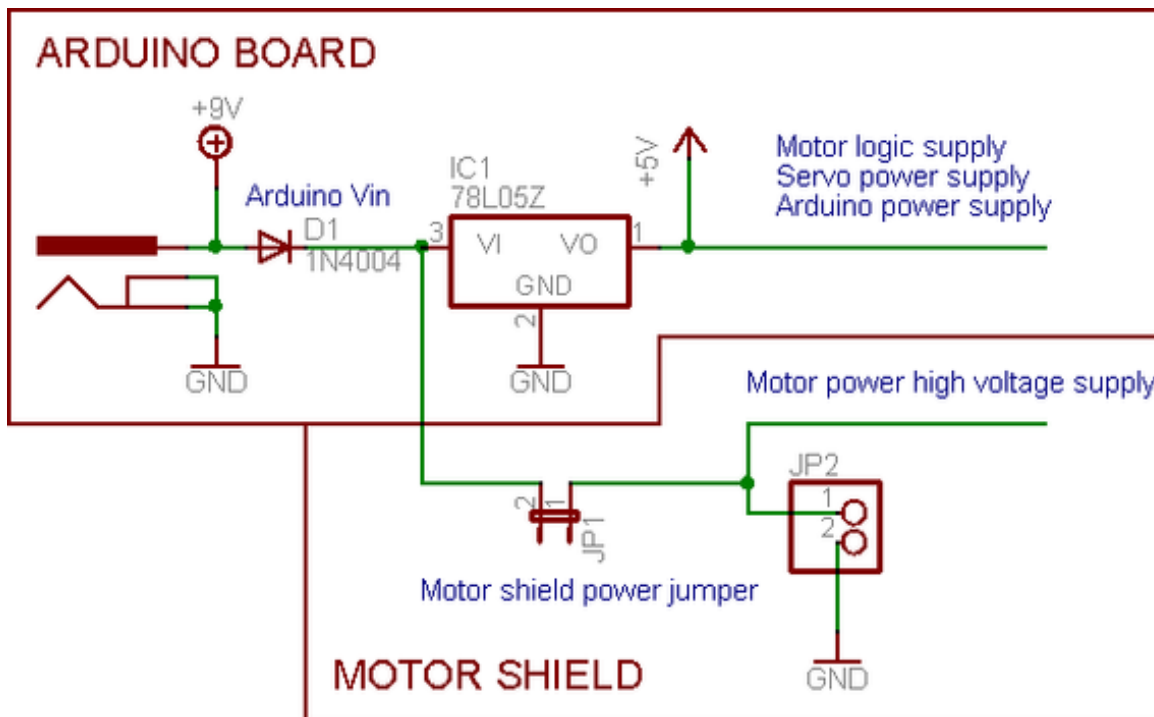

If you would like to have a **single DC power supply for the Arduino and motors**, simply plug it into the DC jack on the Arduino or the 2-pin PWR_EXT block on the shield. Place the power jumper on the motor shield.

If you have a Diecimila Arduino, set the Arduino power source jumper to EXT.

Note that you may have problems with Arduino resets if the battery supply is not able to provide constant power, and it is not a suggested way of powering your motor project

If you would like to have the **Arduino powered off of USB** and the **motors powered off of a DC power supply**, plug in the USB cable. Then connect the motor supply to the PWR_EXT block on

the shield. Do not place the jumper on the shield. This is a suggested method of powering your motor project

(If you have a Diecimila Arduino, don't forget to set the Arduino power jumper to USB. If you have a Diecimila, you can alternately do the following: plug the DC power supply into the Arduino, and place the jumper on the motor shield.)

If you would like to have **2 seperate DC power supplies for the Arduino and motors**. Plug in the supply for the Arduino into the DC jack, and connect the motor supply to the PWR_EXT block. Make sure the jumper is removed from the motor shield.

If you have a Diecimila Arduino, set the Arduino jumper to EXT. This is a suggested method of powering your motor project

Either way, if you want to use the DC motor/Stepper system the motor shield LED should be lit indicating good motor power

Using RC Servos

This tutorial is for the now ancient V1 Motor shield. Chances are you have a V2, check out the tutorial <https://learn.adafruit.com/adafruit-motor-shield-v2-for-arduino> This tutorial is for historical reference and previous customers only!

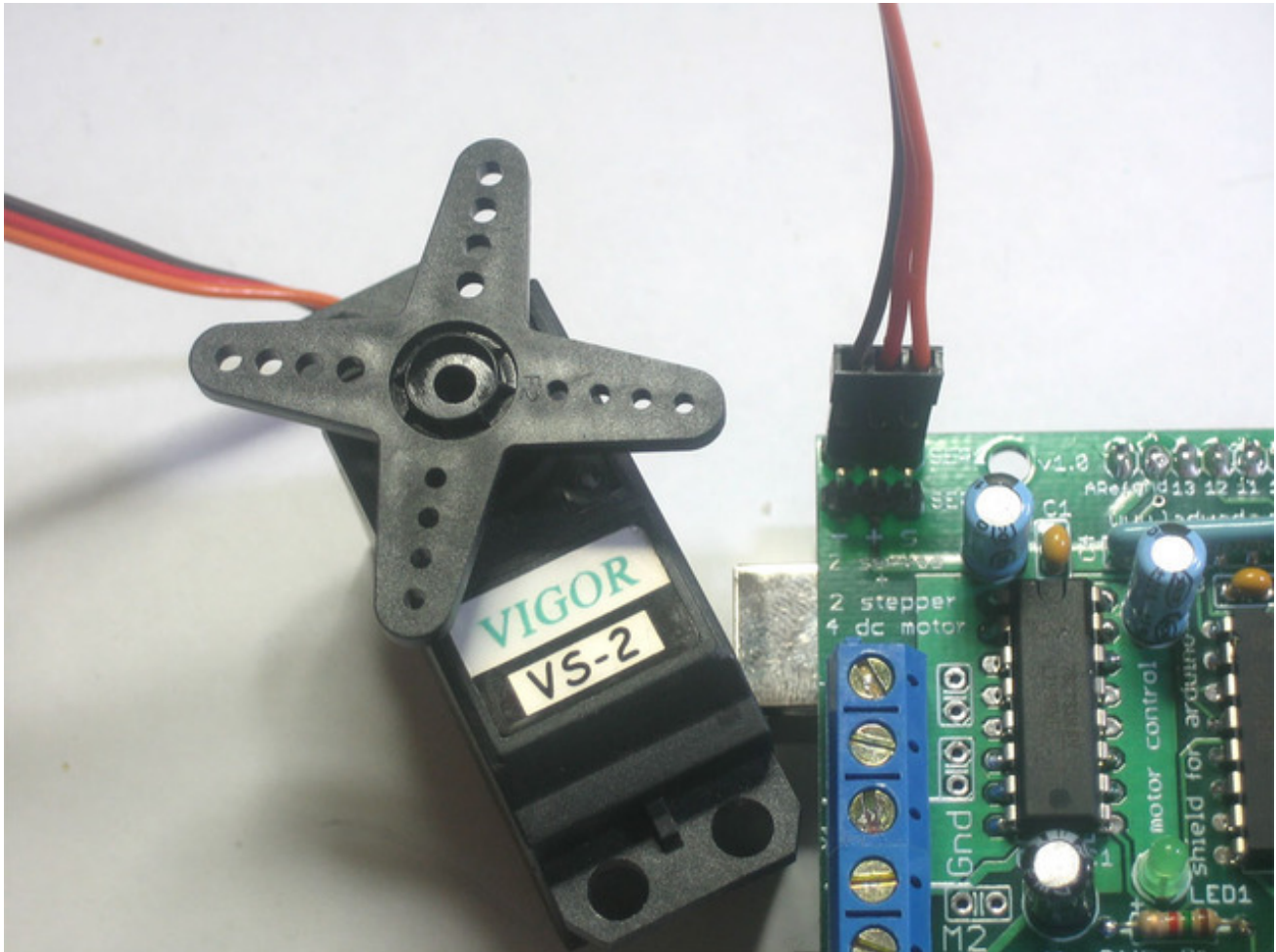

Hobby servos are the easiest way to get going with motor control. They have a 3-pin 0.1" female header connection with +5V, ground and signal inputs. The motor shield simply brings out the 16bit PWM output lines to two 3-pin headers so that its easy to plug in and go. They can take a lot of power so a 9V battery wont last more than a few minutes!

The nice thing about using the onboard PWM is that its very precise and goes about its business in the background. You can use the built in **Servo** library

Using the servos is easy, please read the official Arduino documentation for how to use them and see the example Servo sketches in the IDE (<http://adafru.it/aOD>).

Power for the Servos comes from the Arduino's on-board 5V regulator, powered directly from

the USB or DC power jack on the Arduino. If you need an external supply, cut the trace right below the servo pins (on v1.2 boards) and connect a 5V or 6V DC supply directly. Using an external supply is for advanced users as you can accidentally destroy the servos by connecting a power supply incorrectly!

When using the external supply header for servos, take care that the bottom of the header pins do not contact the metal USB port housing on the Arduino. A piece of electrical tape on the housing will protect against shorts.

Using Stepper Motors

This tutorial is for the now ancient V1 Motor shield. Chances are you have a V2, check out the tutorial <https://learn.adafruit.com/adafruit-motor-shield-v2-for-arduino> This tutorial is for historical reference and previous customers only!

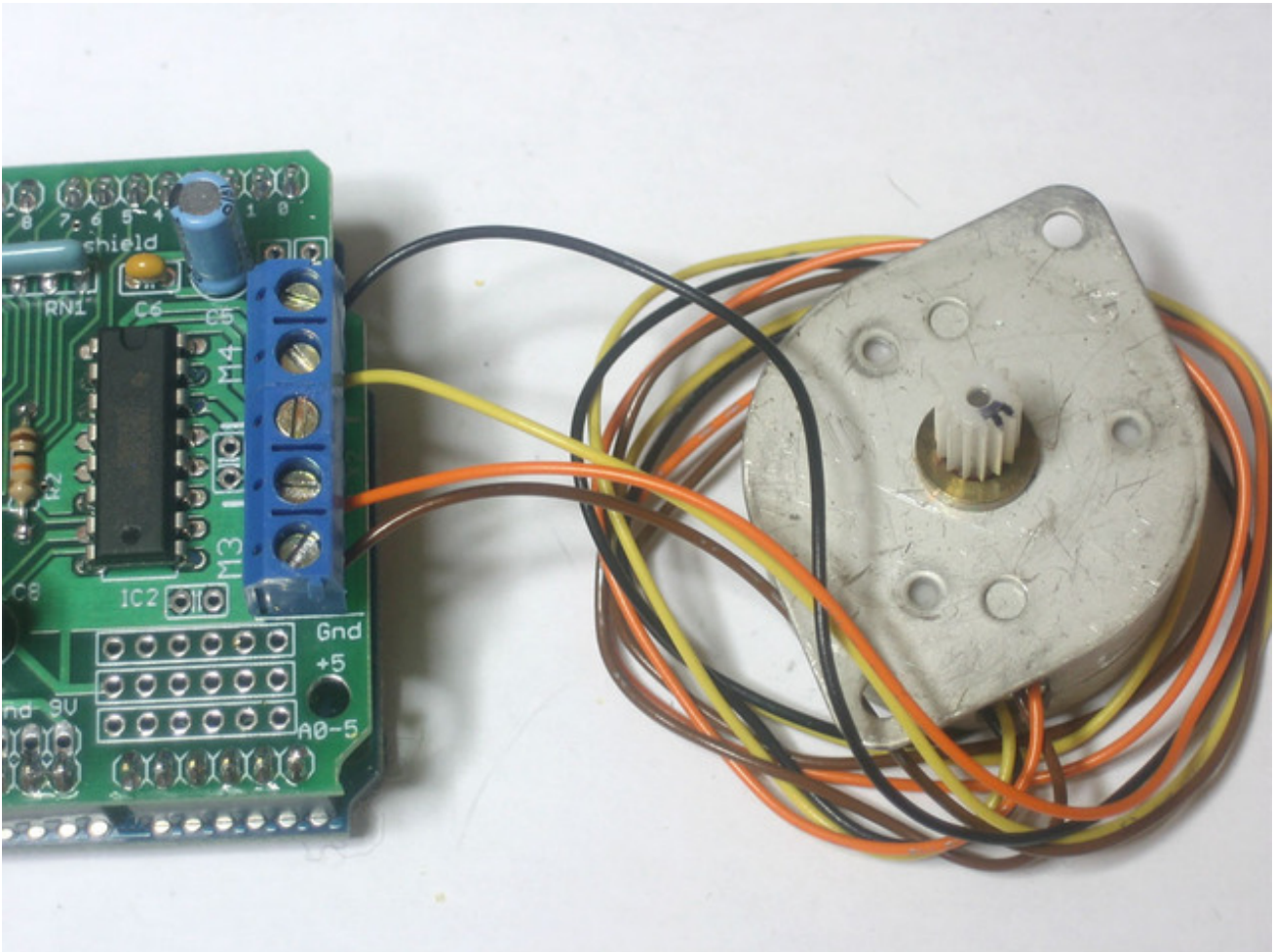

Stepper motors are great for (semi-)precise control, perfect for many robot and CNC projects. This motor shield supports up to 2 stepper motors. The library works identically for bi-polar and uni-polar motors

For unipolar motors: to connect up the stepper, first figure out which pins connected to which coil, and which pins are the center taps. If its a 5-wire motor then there will be 1 that is the center tap for both coils. [Theres plenty of tutorials online on how to reverse engineer the coils pinout. \(http://adafru.it/aOO\)](http://adafru.it/aOO) The center taps should both be connected together to the GND terminal on the motor shield output block. then coil 1 should connect to one motor port (say M1 or M3) and coil 2 should connect to the other motor port (M2 or M4).

For bipolar motors: its just like unipolar motors except theres no 5th wire to connect to ground. The code is exactly the same.

Running a stepper is a little more intricate than running a DC motor but its still very easy

1. Make sure you `#include <AFMotor.h>`
2. Create the stepper motor object with **AF_Stepper(steps, stepper#)** to setup the motor H-bridge and latches. **Steps** indicates how many steps per revolution the motor has. a 7.5degree/step motor has $360/7.5 = 48$ steps. **Stepper#** is which port it is connected to. If you're using M1 and M2, its port 1. If you're using M3 and M4 it's port 2
3. Set the speed of the motor using **setSpeed(rpm)** where **rpm** is how many revolutions per minute you want the stepper to turn.
4. Then every time you want the motor to move, call the **step(#steps, direction, steptype)** procedure. **#steps** is how many steps you'd like it to take. **direction** is either **FORWARD** or **BACKWARD** and the step type is **SINGLE, DOUBLE, INTERLEAVE** or **MICROSTEP**. "Single" means single-coil activation, "double" means 2 coils are activated at once (for higher torque) and "interleave" means that it alternates between single and double to get twice the resolution (but of course its half the speed). "Microstepping" is a method where the coils are PWM'd to create smooth motion between steps. Theres tons of [information about the pros and cons of these different stepping methods in the resources page. \(http://adafru.it/aOO\)](http://adafru.it/aOO) You can use whichever stepping method you want, changing it "on the fly" to as you may want minimum power, more torque, or more precision.
5. By default, the motor will 'hold' the position after its done stepping. If you want to release all the coils, so that it can spin freely, call **release()**
6. The stepping commands are 'blocking' and will return once the steps have finished.

Because the stepping commands 'block' - you have to instruct the Stepper motors each time you want them to move. If you want to have more of a 'background task' stepper control, [check out AccelStepper library \(http://adafru.it/aOL\)](http://adafru.it/aOL) (install similarly to how you did with AFMotor) which has some examples for controlling two steppers simultaneously with varying acceleration

```
#include <AFMotor.h>

AF_Stepper motor(48, 2);

void setup() {
  Serial.begin(9600);      // set up Serial library at 9600 bps
  Serial.println("Stepper test!");

  motor.setSpeed(10); // 10 rpm

  motor.step(100, FORWARD, SINGLE);
  motor.release();
  delay(1000);
}

void loop() {
  motor.step(100, FORWARD, SINGLE);
  motor.step(100, BACKWARD, SINGLE);

  motor.step(100, FORWARD, DOUBLE);
  motor.step(100, BACKWARD, DOUBLE);

  motor.step(100, FORWARD, INTERLEAVE);
  motor.step(100, BACKWARD, INTERLEAVE);

  motor.step(100, FORWARD, MICROSTEP);
  motor.step(100, BACKWARD, MICROSTEP);
}
```

Using DC Motors

This tutorial is for the now ancient V1 Motor shield. Chances are you have a V2, check out the tutorial <https://learn.adafruit.com/adafruit-motor-shield-v2-for-arduino> This tutorial is for historical reference and previous customers only!

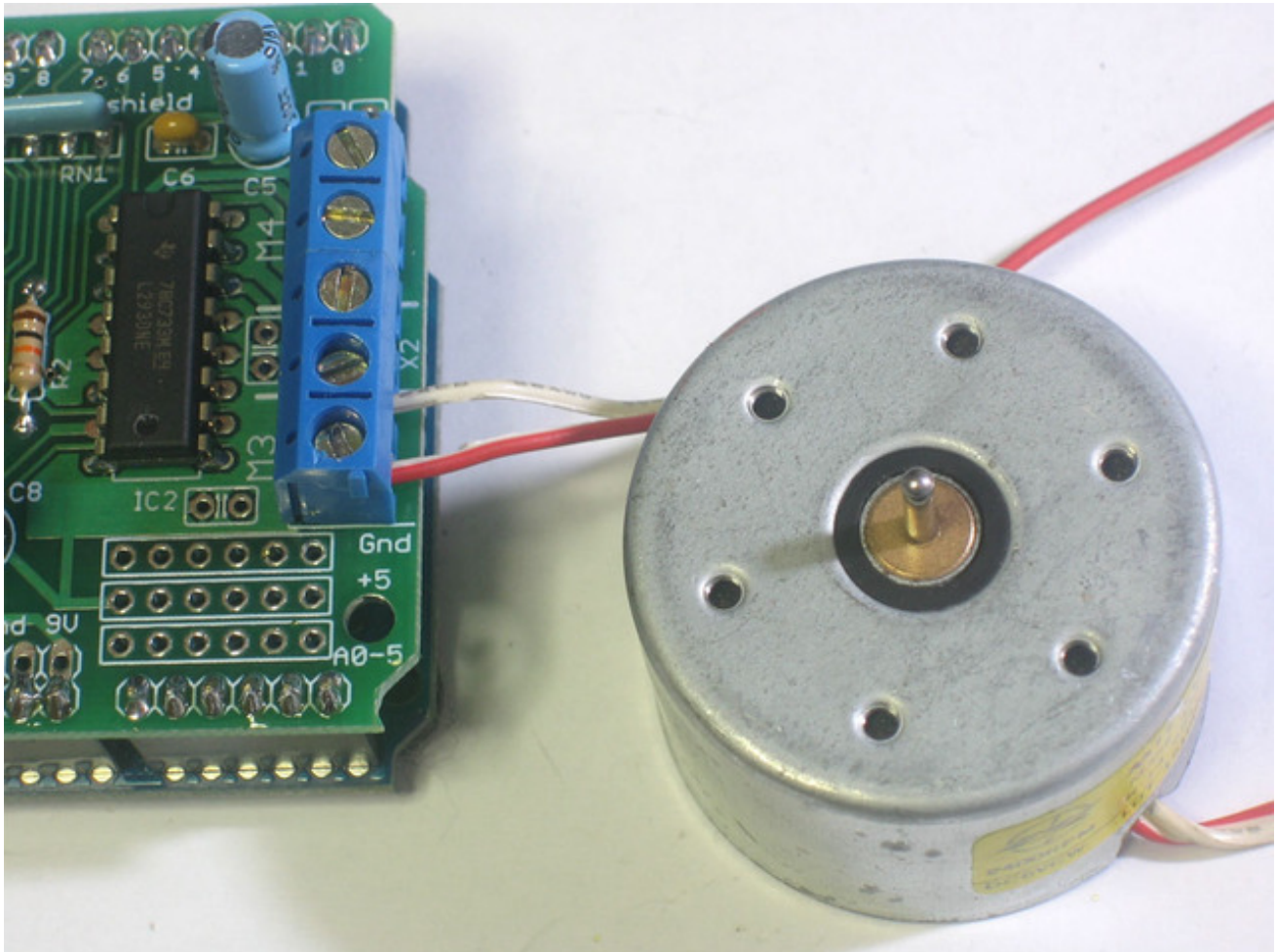

DC motors are used for all sort of robotic projects.

The motor shield can drive up to 4 DC motors bi-directionally. That means they can be driven forwards and backwards. The speed can also be varied at 0.5% increments using the high-quality built in PWM. This means the speed is very smooth and won't vary!

Note that the H-bridge chip is not meant for driving loads over 0.6A or that peak over 1.2A so this is for *small* motors. Check the datasheet for information about the motor to verify its OK.

To connect a motor, simply solder two wires to the terminals and then connect them to either the **M1**, **M2**, **M3**, or **M4**. Then follow these steps in your sketch

1. Make sure you `#include <AFMotor.h>`
2. Create the `AF_DCMotor` object with `AF_DCMotor(motor#, frequency)`, to setup the motor H-bridge and latches. The constructor takes two arguments. The first is which port the motor is connected to, **1, 2, 3** or **4**. *frequency* is how fast the speed controlling signal is. For motors 1 and 2 you can choose `MOTOR12_64KHZ`, `MOTOR12_8KHZ`, `MOTOR12_2KHZ`, or `MOTOR12_1KHZ`. A high speed like 64KHz wont be audible but a low speed like 1KHz will use less power. Motors 3 & 4 are only possible to run at 1KHz and will ignore any setting given
3. Then you can set the speed of the motor using `setSpeed(speed)` where the *speed* ranges from 0 (stopped) to 255 (full speed). You can set the speed whenever you want.
4. To run the motor, call `run(direction)` where *direction* is **FORWARD**, **BACKWARD** or **RELEASE**. Of course, the Arduino doesn't actually know if the motor is 'forward' or 'backward', so if you want to change which way it thinks is forward, simply swap the two wires from the motor to the shield.

```
#include <AFMotor.h>

AF_DCMotor motor(2, MOTOR12_64KHZ); // create motor #2, 64KHz pwm

void setup() {
  Serial.begin(9600);      // set up Serial library at 9600 bps
  Serial.println("Motor test!");

  motor.setSpeed(200);    // set the speed to 200/255
}

void loop() {
  Serial.print("tick");

  motor.run(FORWARD);     // turn it on going forward
  delay(1000);

  Serial.print("tock");
  motor.run(BACKWARD);   // the other way
  delay(1000);

  Serial.print("tack");
  motor.run(RELEASE);    // stopped
  delay(1000);
}
```

AF_DCMotor Class

This tutorial is for the now ancient V1 Motor shield. Chances are you have a V2, check out the tutorial <https://learn.adafruit.com/adafruit-motor-shield-v2-for-arduino> This tutorial is for historical reference and previous customers only!

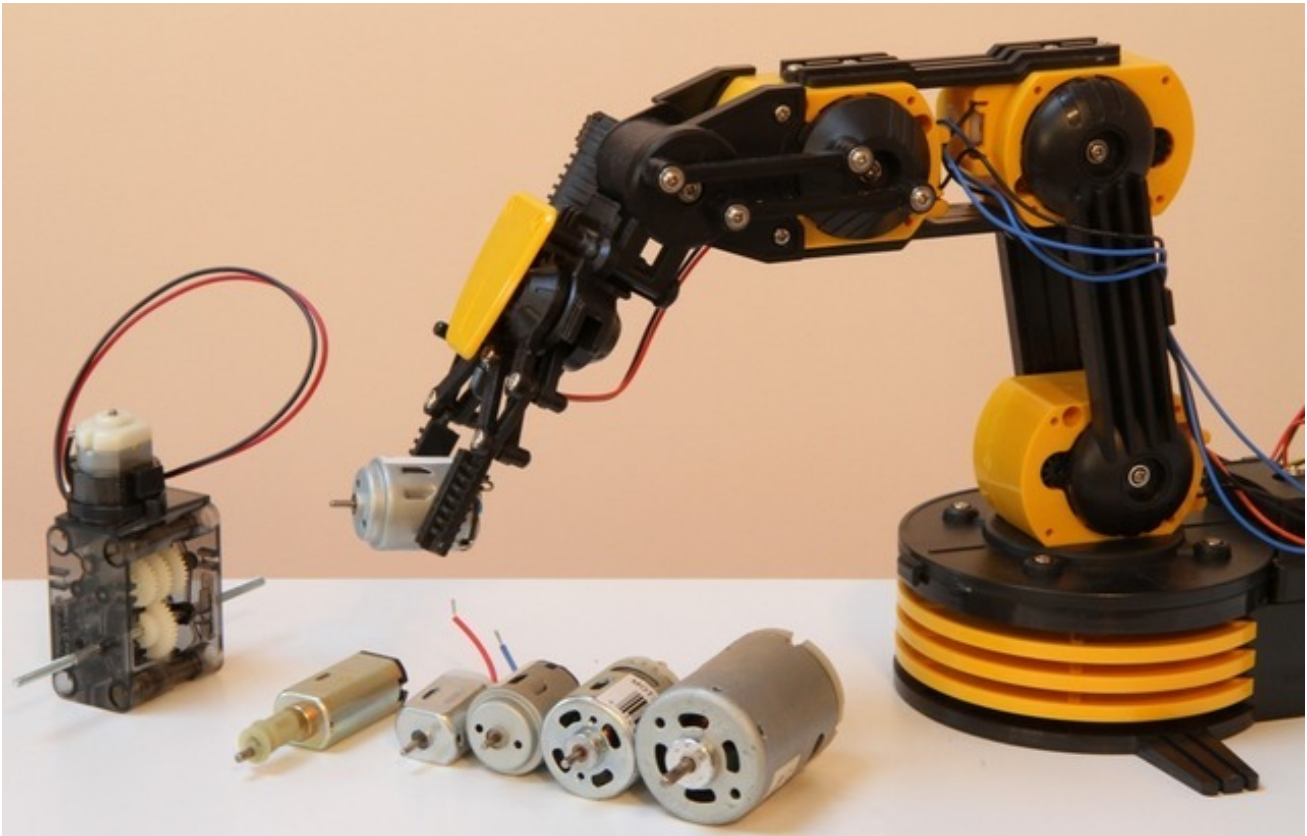

The AF_DCMotor class provides speed and direction control for up to four DC motors when used with the Adafruit Motor Shield. To use this in a sketch you must first add the following line at the beginning of your sketch:

```
#include <AFMotor.h>
```

AF_DCMotor *motorname*(*portnum*, *freq*)

This is the constructor for a DC motor. Call this constructor once for each motor in your sketch. Each motor instance must have a different name as in the example below.

Parameters:

- **port num** - selects which channel (1-4) of the motor controller the motor will be connected to

- **freq** - selects the PWM frequency. If no frequency is specified, 1KHz is used by default.

Frequencies for channel 1 & 2 are:

- MOTOR12_64KHZ
- MOTOR12_8KHZ
- MOTOR12_2KHZ
- MOTOR12_1KHZ

Frequencies for channel 3 & 4 are:

- MOTOR34_64KHZ
- MOTOR34_8KHZ
- MOTOR34_1KHZ

Example:

```
AF_DCMotor motor4(4); // define motor on channel 4 with 1KHz default PWM
AF_DCMotor left_motor(1, MOTOR12_64KHZ); // define motor on channel 1 with 64KHz PWM
```

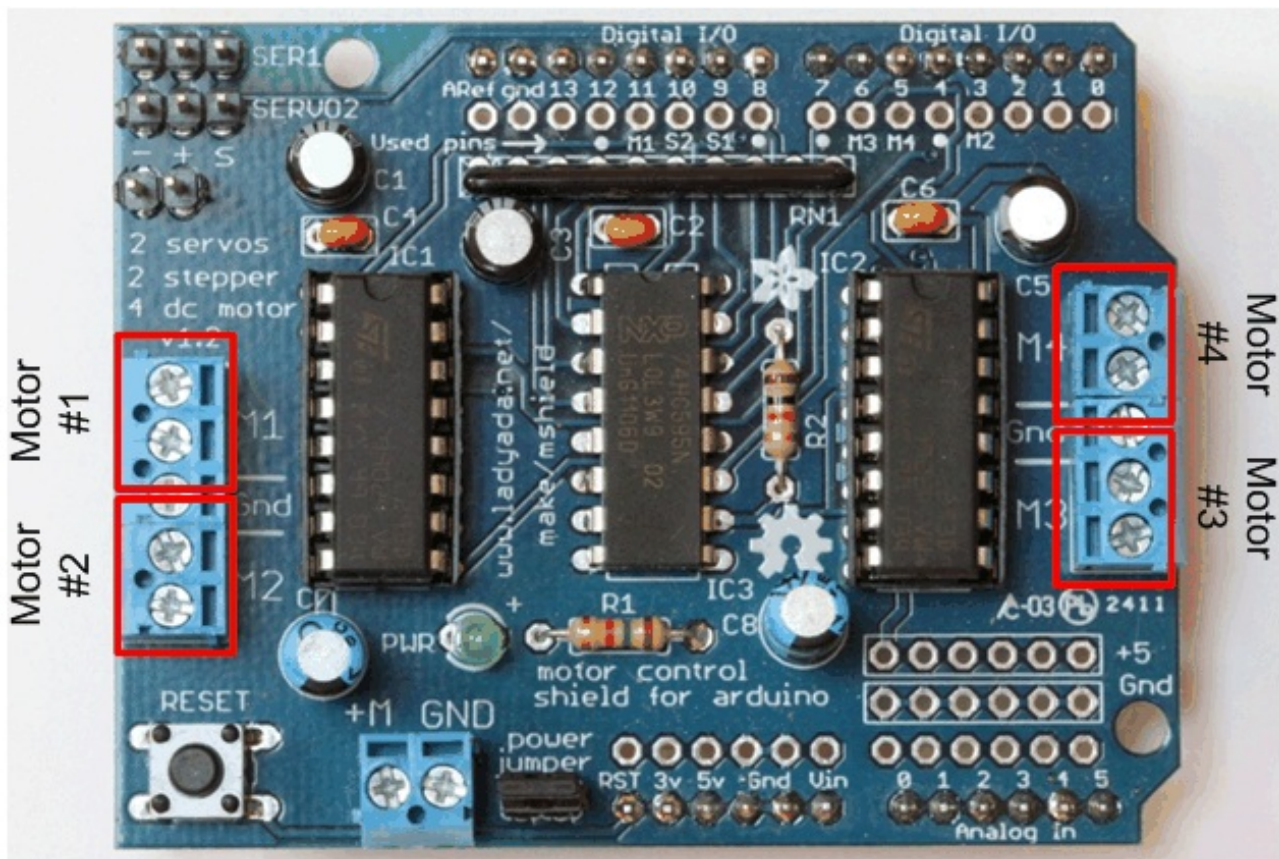

***Note:** Higher frequencies will produce less audible hum in operation, but may result in lower torque with some motors.*

setSpeed(*speed*)

Sets the speed of the motor.

Parameters:

- **speed**- Valid values for 'speed' are between 0 and 255 with 0 being off and 255 as full throttle.

Example:

***Note:** DC Motor response is not typically linear, and so the actual RPM will not necessarily be proportional to the programmed speed.*

run(*cmd*)

Sets the run-mode of the motor.

Parameters:

- **cmd** - the desired run mode for the motor

Valid values for cmd are:

- **FORWARD** - run forward (actual direction of rotation will depend on motor wiring)
- **BACKWARD** - run backwards (rotation will be in the opposite direction from FORWARD)
- **RELEASE** - Stop the motor. This removes power from the motor and is equivalent to setSpeed(0). The motor shield does not implement dynamic breaking, so the motor may take some time to spin down

Example:

```
motor.run(FORWARD);  
delay(1000); // run forward for 1 second  
motor.run(RELEASE);  
delay(100); // 'coast' for 1/10 second  
motor.run(BACKWARDS); // run in reverse
```

AF_Stepper Class

This tutorial is for the now ancient V1 Motor shield. Chances are you have a V2, check out the tutorial <https://learn.adafruit.com/adafruit-motor-shield-v2-for-arduino> This tutorial is for historical reference and previous customers only!



The AF_Stepper class provides single and multi-step control for up to 2 stepper motors when used with the Adafruit Motor Shield. To use this in a sketch you must first add the following line at the beginning of your sketch:

```
#include <AFMotor.h>
```

AF_Stepper *steppername(steps, portnumber)*

The AF_Stepper constructor defines a stepper motor. Call this once for each stepper motor in your sketch. Each stepper motor instance must have a unique name as in the example below.

Parameters:

- **steps** - declare the number of steps per revolution for your motor.
- **num** - declare how the motor will be wired to the shield.

Valid values for 'num' are 1 (channels 1 & 2) and 2 (channels 3 & 4).

Example:

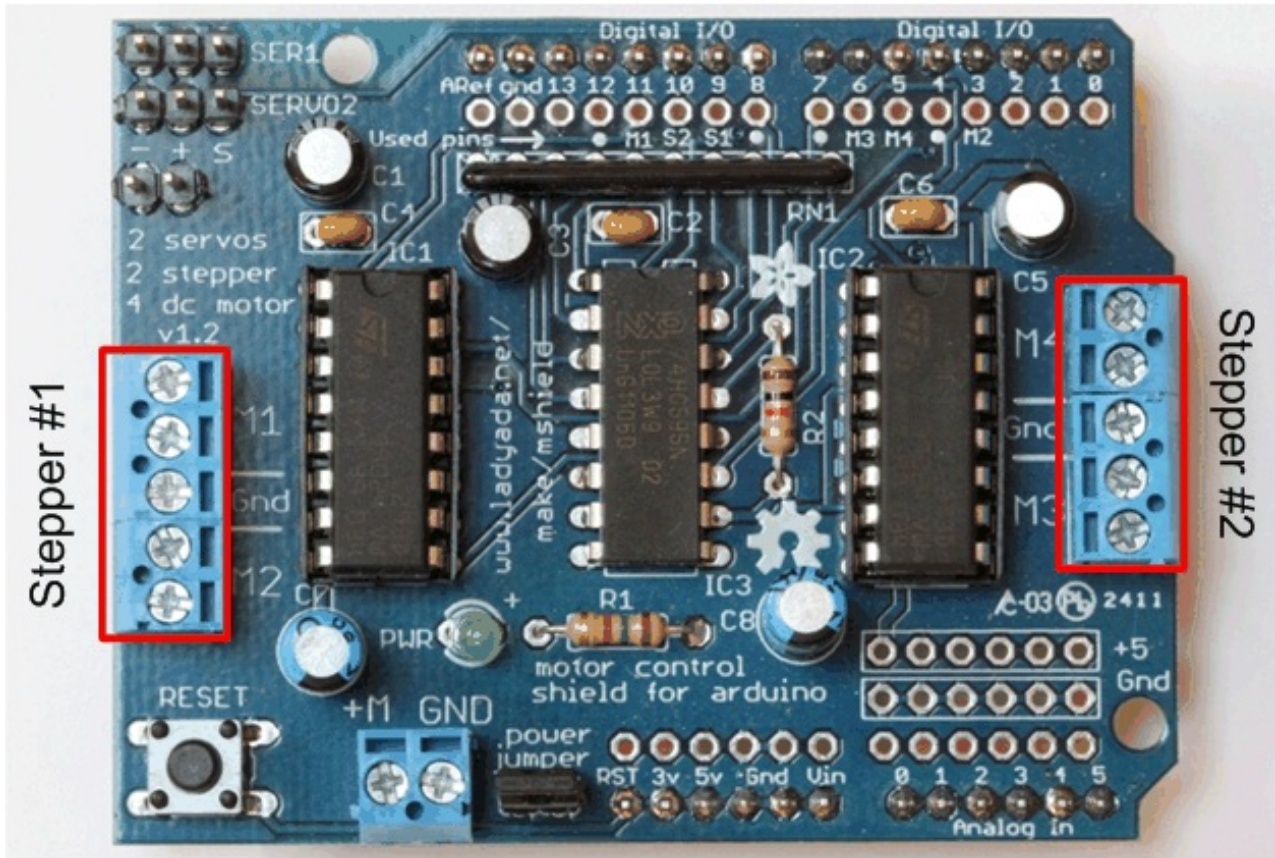

```
AF_Stepper Stepper1(48, 1); // A 48-step-per-revolution motor on channels 1 & 2
AF_Stepper Stepper2(200, 2); // A 200-step-per-revolution motor on channels 3 & 4
```

step(steps, direction, style)

Step the motor.

Parameters:

- **steps** - the number of steps to turn
- **direction** - the direction of rotation (**FORWARD** or **BACKWARD**)
- **style** - the style of stepping:

Valid values for 'style' are:

- **SINGLE** - One coil is energized at a time.
- **DOUBLE** - Two coils are energized at a time for more torque.
- **INTERLEAVE** - Alternate between single and double to create a half-step in between. This can result in smoother operation, but because of the extra half-step, the speed is reduced by half too.
- **MICROSTEP** - Adjacent coils are ramped up and down to create a number of 'micro-

steps' between each full step. This results in finer resolution and smoother rotation, but with a loss in torque.

Note: *Step is a synchronous command and will not return until all steps have completed. For concurrent motion of two motors, you must handle the step timing for both motors and use the "onestep()" function below.*

```
Stepper1.step(100, FORWARD, DOUBLE); // 100 steps forward using double coil stepping
Stepper2.step(100, BACKWARD, MICROSTEP); // 100 steps backward using double microstepping
```

setSpeed(*RPMspeed*)

set the speed of the motor

Parameters:

- Speed - the speed in RPM

Note: *The resulting step speed is based on the 'steps' parameter in the constructor. If this does not match the number of steps for your motor, your actual speed will be off as well.*

Example:

```
Stepper1.setSpeed(10); // Set motor 1 speed to 10 rpm
Stepper2.setSpeed(30); // Set motor 2 speed to 30 rpm
```

onestep(*direction, stepstyle*)

Single step the motor.

Parameters:

- **direction** - the direction of rotation (**FORWARD** or **BACKWARD**)
- **stepstyle** - the style of stepping:

Valid values for 'style' are:

- **SINGLE** - One coil is energized at a time.
- **DOUBLE** - Two coils are energized at a time for more torque.
- **INTERLEAVE** - Alternate between single and double to create a half-step in between. This can result in smoother operation, but because of the extra half-step, the speed is reduced by half too.

- **MICROSTEP** - Adjacent coils are ramped up and down to create a number of 'micro-steps' between each full step. This results in finer resolution and smoother rotation, but with a loss in torque.

Example:

```
Stepper1.onestep(FORWARD, DOUBLE); // take one step forward using double coil stepping
```

release()

Release the holding torque on the motor. This reduces heating and current demand, but the motor will not actively resist rotation.

Example:

```
Stepper1.release(); // stop rotation and turn off holding torque.
```

Resources

Motor ideas and tutorials

- [Wikipedia has tons of information \(http://adafru.it/aOF\)](http://adafru.it/aOF) on steppers
- [Jones on stepper motor types \(http://adafru.it/aOH\)](http://adafru.it/aOH)
- [Jason on reverse engineering the stepper wire pinouts \(http://adafru.it/aOI\)](http://adafru.it/aOI)

Downloads

This tutorial is for the now ancient V1 Motor shield. Chances are you have a V2, check out the tutorial <https://learn.adafruit.com/adafruit-motor-shield-v2-for-arduino> This tutorial is for historical reference and previous customers only!

Schematics & Layout

You can grab the latest Schematic, Layout files (EagleCAD format from github. Click the **ZIP download** button at top middle to download the entire zip. (<http://adafru.it/aOJ>)

Firmware

- [Arduino Stepper/Servo software library with microstepping support \(http://adafru.it/aOK\)](http://adafru.it/aOK).
To install, click on **Downloads** in the middle of the page, select **Download as zip** and uncompress the folder.
Rename the folder to **AFmotor** (check that the renamed folder contains the .cpp and .h files) and install into the **Arduinosketches/libraries** folder. [For information how to use and install libraries, see our tutorial \(http://adafru.it/aYG\)](#)! This version now works with with the Mega. Public domain!
- [AccelStepper library \(http://adafru.it/aOL\)](http://adafru.it/aOL) with AFMotor support. This library allows for advanced stepper control including acceleration and deceleration, and concurrent stepper control! *You still need AFmotor above!*
To install, click on **Download** in the middle of the page, select **Download as zip** and uncompress the folder.
Rename the folder to **AccelStepper** (check that the renamed folder contains the .cpp and .h files) and install into the **Arduinosketches/libraries** folder. [For information how to use and install libraries, see our tutorial \(http://adafru.it/aYG\)](#)!

Forums

[Forums \(http://adafru.it/aOM\)](http://adafru.it/aOM)



Handsontec.com

We have the parts for your ideas

HandsOn Technology provides a multimedia and interactive platform for everyone interested in electronics. From beginner to diehard, from student to lecturer. Information, education, inspiration and entertainment. Analog and digital, practical and theoretical; software and hardware.



open source
hardware

HandsOn Technology support Open Source Hardware (OSHW) Development Platform.

Learn : Design : Share

www.handsontec.com

The Face behind our product quality...

In a world of constant change and continuous technological development, a new or replacement product is never far away – and they all need to be tested.

Many vendors simply import and sell without checks and this cannot be the ultimate interests of anyone, particularly the customer. Every part sell on Handsotec is fully tested. So when buying from Handsotec products range, you can be confident you're getting outstanding quality and value.

We keep adding the new parts so that you can get rolling on your next project.



www.handsontec.com

[Breakout Boards & Modules](#)



[Connectors](#)



www.handsontec.com

[Electro-Mechanical Parts](#)



www.handsontec.com

[Engineering Material](#)



www.handsontec.com

[Mechanical Hardware](#)



[Electronics Components](#)

P



www.handsontec.com

[Power Supply](#)



[Arduino Board & Shield](#)

[Tools & Accessory](#)



www.handsontec.com

[Tools & Accessory](#)